

TMG3202 AC Quick Installation Guide, 9010-00183-2A, Issue 3.2

1

Items not included in this box that you will need:

- Two AC power cords
- 19" equipment rack

2

In the box, you will find:

- One TMG3202
- One set of mounting brackets with screws
- One DB-9 to RJ-45 adapter
- SCSI Cables and Patch Panels, if applicable
- Three RJ45 Ethernet Straight Cables (male-male)
- One warranty sheet
- One packing slip
- One TMG3202 Quick Installation Guide

3

- A) Install rack-mounting hardware on TMG3202 and install on equipment rack.
- B) Connect Ethernet port to Linux Host.

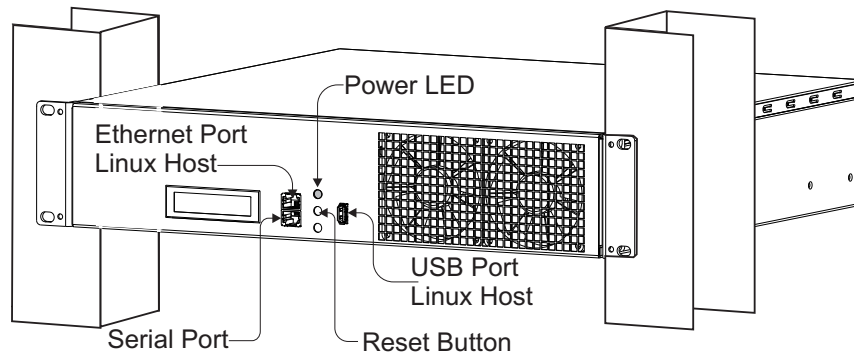

4

Connect to VoIP network.

*NOTE:
Ethernet ports (ETH-1&2), and
TMS ports (TMS-1&2) are
unused.

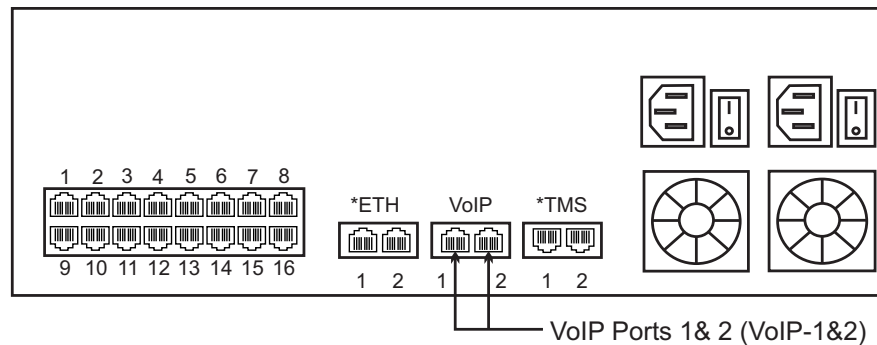

5

Connect to PSTN Network, using one of the following options:

- RJ-48 Interface (T1/E1/J1)
- Dual BNC (DS3)
- SCSI Interface (T1/E1/J1), a patch panel is provided
- Optical Interface (OC3/STM-1)

RJ-48

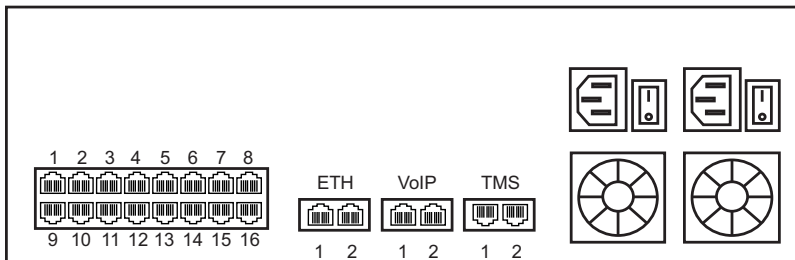

SCSI

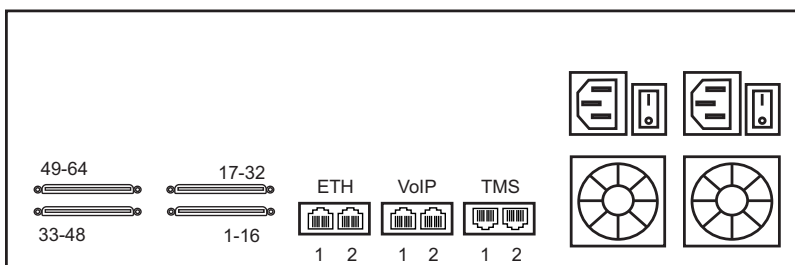

DS3

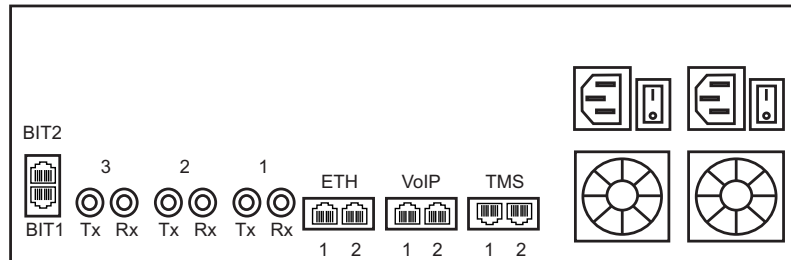

STM 1

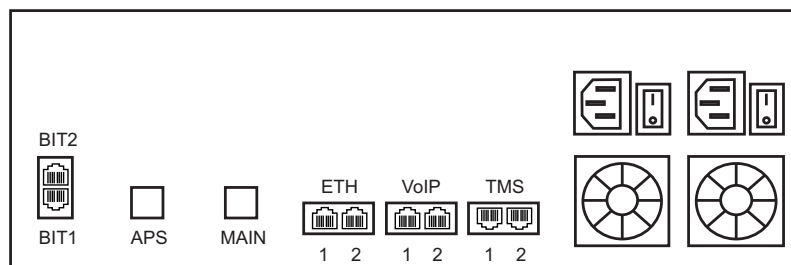

6

A) Connect to two independent power sources (if only one power source is used, press the green button at the rear of the unit to disable the audible alarm).

B) Verify Power LED = Solid Green (Refer to Panel 3)

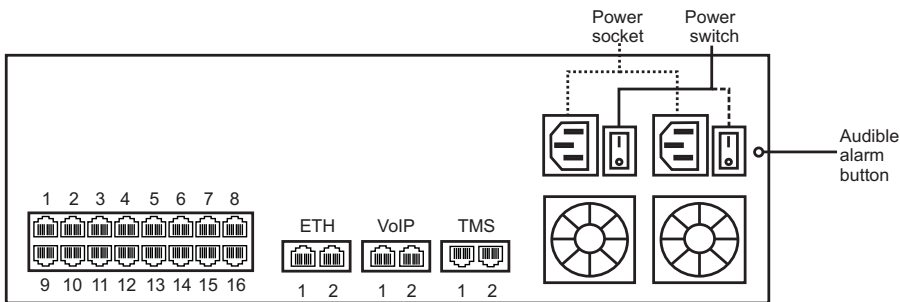

7

- Connect to the Linux host through management Ethernet OR serial connector. The IP address of the management port is assigned through DHCP. If DHCP is not available, use the serial cable to connect to the TMG Linux Host for the first time.
- Default HOSTNAME is the Linux Host serial number, which can be found in the packing slip.
- Refer to the "Read Me" sheet for the username and password to log onto the Linux OS. Navigate to: `HTTP://HOSTNAME:12358`, to configure the Tmedia unit. (username/password: root/root)

Next Steps? More information is available on the TelcoBridges TB Wiki at: <http://docs.telcobridges.com/mediawiki/index.php/TMG3200>