

TelcoBridges

Installation Guide

800 Series Gateway Standalone & 800 Series Gateway 1+1

October 29, 2013



The information in this document as well as product specifications referred to throughout, are subject to change without notice. No part of this document may be reproduced or transmitted in any form or by any means, electronic or mechanical, for any purpose, without the express written permission of TelcoBridges. TelcoBridges may have patents or pending patent applications, trademarks, copyrights, or other intellectual property rights covering subject matter in this document. The furnishing of this document does not give you license to these patents, trademarks, copyrights, or other intellectual property except as expressly provided in any written license agreement from TelcoBridges Inc.

The information provided in this document is intended as a guide only. For the latest detailed engineering specifications, please contact TelcoBridges TB Support or visit the TBWiki: <http://docs.telcobridges.com>. TelcoBridges is committed to continually improving product designs; as a result, product specifications may be subject to change without notification.
© 2003-2013 TelcoBridges. All rights reserved.

TelcoBridges, Tmedia, TMG800, TMG3200, TMG3200-RJ, TMG3200-TE, TMG3200-DS3, TMG3200-STM1, TMG7800, TMG7800-TE, TMG7800-DS3, TMG7800-STM1, TMG7800-CTRL, TMG-CONTROL, TMG7800-TMS, Tsig, TSG800, TSG3200, TSG3200-RJ, TSG3200-TE, TSG3200-DS3, TSG3200-STM1, Ttrans, TMGIP800, TMGIP3200, TMGIP7800, Tmedia 1+1, Tmedia N+1, TMG800+1, TMG3200-TE+1, TMG3200-DS3+1, TMG3200-STM1+1, TMG7800-TE+1, TMG7800-DS3+1, TMG7800-STM1+1, Tdev, TMP800, TMP6400, TMP6400-CTRL, TMP6400-TMS, Tmonitor, TM1000, TM3000, Toopack, Toolpack API, TB640, TB-8, TB-16, and TB-Video, are trademarks of TelcoBridges Inc. All other trademarks are the property of their owners. This information is subject to change without notice.

Issue 3.0n

HEAD OFFICE
TelcoBridges Inc.
91 rue de la Barre, Suite 01
Boucherville, QC, J4B 2X6
CANADA
www.telcobridges.com

T +1 450 655 8993
F +1 450 655 9511
info@telcobridges.com

TB Support - Technical Support
Tel: +1 438 338 2100
support@telcobridges.com
www.telcobridges.com/en/tbsupport.aspx

Preface



About this Guide

This guide provides installation, and setup procedures for 800 series standalone and 800 series 1+1 systems.

Conventions

Terminology	Description
800 series gateway	This term is used when a description applies to both the 800 series standalone and 800 series 1+1 system.
800 series standalone	This term is used when a description applies to the 800 series unit operating as a standalone unit.
800 series 1+1 System	This term is used when a description applies to the 800 series unit operating in conjunction with the 800+1 series unit. This term also includes the 1+1 patch panel.
800 series unit	This term is used when a description applies to all variations of the 800 series units, such as: TMG800, TSG800, and TMGIP800.
800 series +1 unit	This term is used when a description applies to all variations of the 800 series +1 units, such as TMG800 +1, TSG800 +1, or TMGIP800 +1.
1+1 Patch Panel	This term is used as a generic reference to 1+1 patch panel, which enables an 800 series to connect to an 800 series +1.

To help guide you through the installation of your product, we have produced the following icons. Please take note of the icon which represents the type of installation you are conducting and follow it throughout this guide to ensure proper install and set-up.

Graphics	Description
	This icon appears in the margins of pages describing the 800 series operating as a standalone unit. If you are installing a standalone unit read and follow the instructions provided in those sections and pages.
	This icon appears in the margins of pages describing the 800 series unit operating in conjunction with an 800 series +1 and 1+1 Patch Panel. If you are installing a 1+1 System read and follow the instructions provided in those sections and pages.

Contact Us

If you have comments about this guide or any other TelcoBridges technical documentation, please send an email to marketing@telcobridges.com.

Table of Contents

Section 1	Introduction.....	1
1.1	Recognizing an 800 Series Standalone versus an 800 Series 1+1 System	2
1.1.1	800 Series Standalone	2
1.1.2	800 Series 1+1 System	2
1.2	Installation Prerequisites	3
1.3	Preventing Electrostatic Discharge Damage.....	4
1.4	Recommended Reading.....	4
Section 2	Installing the Equipment	5
2.1	Package Contents	6
2.1.1	800 Series Standalone Package Contents.....	6
2.1.2	800 Series +1 System Package Contents.....	7
2.2	Rack Mounting the 800 Series Standalone or the 800 Series 1+1 System	9
2.2.1	Prerequisites	9
2.2.2	Vertical Placement of the Equipment	9
2.2.3	Installing the 800 Series Standalone and the 800 Series 1+1 on an Equipment Rack	10
2.3	Choosing your Connection Procedures.....	12
2.4	800 Series Standalone	13
2.4.1	Connecting to the 800 Series Gateway Management Interface.....	14
2.4.2	Connecting to a VoIP Network	15
2.4.3	Connecting to the PSTN.....	16
2.4.4	Powering Up.....	17
2.4.4.1	Connecting to AC Power	17
2.4.4.2	Connecting to DC Power.....	18
2.4.5	Start Up	20
2.4.5.1	Configuring the Role.....	20
2.5	800 Series 1+1 System	21
2.5.1	Connecting to the 800 Series 1+1 System Management Interfaces	22
2.5.2	Connecting to the 800 Series 1+1 System Control Network and VoIP Network(s)	23
2.5.3	Connecting to the PSTN in an 800 Series 1+1 System	24
2.5.4	Powering Up.....	26
2.5.4.1	Connecting to AC Power	26
2.5.4.2	Connecting to DC Power.....	27
2.5.5	Start Up	29
2.6	Adding an 800 +1 Unit to an Existing Standalone; Creating an 800 series 1+1 System...31	
2.6.1	Reconfigure a Standalone Unit as a Primary Unit in an 800 Series 1+1 System.....	31
2.6.2	Install the 800 Series +1 unit on the Equipment Rack	34
2.6.3	Install the 1+1 Patch Panel	34
2.6.4	Connect to the 800 Series 1+1 Management Interface.....	34
2.6.5	Connect to the 800 Series 1+1 Control Network and VoIP Network(s).....	34
2.6.6	Connect to the PSTN Network	35
2.6.7	Power Up the Equipment	35
2.6.8	Start Up	36
2.7	Verifying the LED Status Indications	37

2.8	Powering Down	38
Section 3	Initial System Configuration.....	39
3.1	Connecting to the Serial Port of the 800 Series Gateway	40
3.2	Configuring the Terminal Emulator Application	42
3.3	Connecting to the 800 Series Gateway.....	42
3.4	Retrieving 800 Series Gateway Information.....	43
3.5	Changing the 800 Series Gateway Management Port IP Address	43
3.6	Changing 800 Series Gateway Management Port Passwords	43
3.7	Setting the Time Zone	43
3.8	Configuring the 800 Series Gateway Using the Web Portal.....	44
3.9	Changing VoIP Interface Addresses	44
Section 4	System Backups.....	45
4.1	Creating a Database Backup	46
4.2	Downloading a Database Backup	46
4.3	Uploading a Database Backup.....	46
4.4	Restoring a Database Backup.....	46
Appendix A	Wiring Diagrams.....	47
A.1	RJ48C Wiring Diagram: Crossover and Straight Cables.....	48
A.2	RJ48 Console Wiring Diagram	48



Section 1 Introduction

This section provides an introduction to the installation and setup for the following configurations:



800 Series Standalone: Single gateway unit operating in standalone mode.



800 series 1+1 system: 800 series unit operating in conjunction with an 800 series +1 unit and a 1+1 patch panel.

The following topics are covered:

- Section 1.1 “Recognizing an 800 Series Standalone versus an 800 Series 1+1 System”
- Section 1.2 “Installation Prerequisites”
- Section 1.3 “Preventing Electrostatic Discharge Damage”
- Section 1.4 “Recommended Reading”



1.1 Recognizing an 800 Series Standalone versus an 800 Series 1+1 System



1.1.1 800 Series Standalone

The 800 series standalone consists of one telecom unit. The front and rear views are shown in figure 1.1 on page 2.

The 800 series standalone consists of one telecom unit. The front and rear views are shown in figure 1.1 on page 2.

1.1.2 800 Series 1+1 System

The 800 series 1+1 system, see figure 1.1 on page 2, consists of:

- One telecom unit
- One +1 telecom unit
- One 1+1 patch panel

TMG800/TSG800/TMGIP800 (front view)

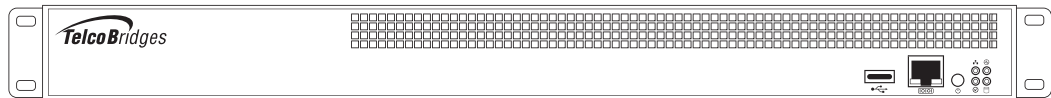

TMG800/TMG800 + 1 and TSG800/TSG800 + 1 (rear view)

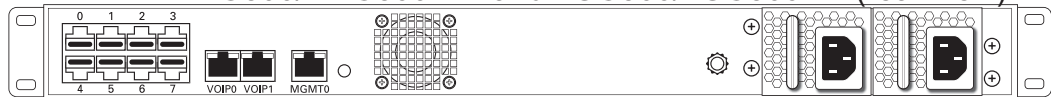

TMGIP800/TMGIP800 + 1 (rear view)

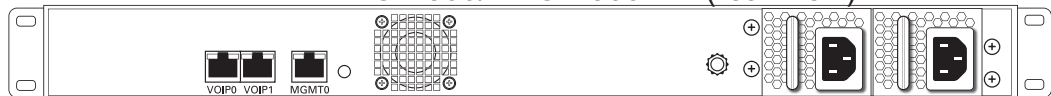

1+1 Patch Panel (RJ)

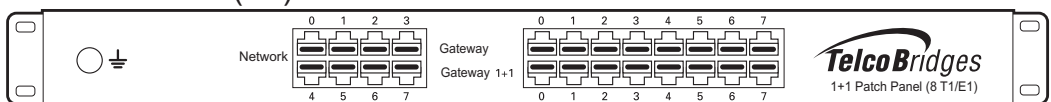



Figure 1.1 Equipment Front and Rear Views

1.2 Installation Prerequisites

For the installation to proceed without interruption, it is important that you verify that you have all necessary materials on hand.



 800 Series Standalone	 800 Series 1+1 System								
<p>Adequate space for the installation of the 800 series standalone. You will need to mount the 800 series unit on a 19" equipment rack (customer provided). Your 800 series unit is a 1U unit.</p> <p>Adequate power supply and power connections. The 800 series unit requires one or two power connections, depending on whether you have purchased the single or redundant power supply option. If you have a redundant power supply, to guarantee an uninterrupted supply of electricity, each power connection must be fed by a dedicated power source.</p> <p>An IP address for the management port. To avoid delays, you should have the IP address, netmask and gateway addresses on hand. Take note that the management port supports DHCP, see Section 2.4.1 "Connecting to the 800 Series Gateway Management Interface" on page 14 for further information.</p>	<p>Adequate space for the installation of your 800 series 1+1 system. You will need to mount the 800 series 1+1 system on a 19" equipment rack (customer provided).</p> <p>Your 1+1 System requires space for the following number of units:</p> <table data-bbox="922 793 1230 926"> <tr> <td>800 Series Unit:</td> <td>1U</td> </tr> <tr> <td>800 Series +1 Unit:</td> <td>1U</td> </tr> <tr> <td>1+1 Patch Panel:</td> <td>1U</td> </tr> <tr> <td>Total:</td> <td>3U</td> </tr> </table> <p>Adequate power supply and power connections. The 800 series and 800 series +1 units require one to two power connections each, depending on whether you have chosen them with single or redundant power supply. To guarantee an uninterrupted supply for the instance of dual power connections, each power connection must be fed by a dedicated power source.</p> <p>An IP address for the management port. To avoid delays, you should have the IP address, netmask and gateway addresses on hand. Take note that the management port supports DHCP, see Section 2.4.1 "Connecting to the 800 Series Gateway Management Interface" on page 14 for further information.</p>	800 Series Unit:	1U	800 Series +1 Unit:	1U	1+1 Patch Panel:	1U	Total:	3U
800 Series Unit:	1U								
800 Series +1 Unit:	1U								
1+1 Patch Panel:	1U								
Total:	3U								



1.3

Preventing Electrostatic Discharge Damage

Electrostatic discharge (ESD) can damage equipment and impair electrical circuitry. It may occur if electronic printed circuit cards are improperly handled and may cause complete or intermittent failure.



Warning

Always follow ESD prevention procedures when removing and replacing modules:

- Ensure that the equipment is grounded.
- Wear an ESD-preventive wrist strap and ensure that it makes good contact with your skin. Connect the wrist strap clip to an unpainted surface of the equipment or the grounded equipment rack in order to channel away all ESD voltage safely to ground. To guard against ESD damage and shocks, the wrist strap and cord must be in proper working condition.
- If no wrist strap is available, and you must work with the equipment, ground yourself by touching a metal part of the chassis.

1.4

Recommended Reading

This document assumes that you have a clear understanding of the installation of the equipment described in this document and have been trained to work with the equipment. If you have any technical questions, TelcoBridges TB Support (technical support team) can be reached at the following numbers or an email can be sent to: support@telcobridges.com.

- Americas & Europe Technical Support Centre (GMT-05:00, Montreal):
Telephone: +1-450-655-8993 x131 or x102
- Asia Technical Support Centre (GMT +08:00, Hong Kong)
Telephone: +852-3749-9818
- 24/7 International Support
Telephone: +1-866-438-4703

Documents exploring various aspects of the product are available on the TB Wiki:
<http://docs.telcobridges.com>



Section 2 Installing the Equipment

This section provides information about the following topics:

- Section 2.1 “Package Contents”
- Section 2.2 “Rack Mounting the 800 Series Standalone or the 800 Series 1+1 System”
- Section 2.4 “800 Series Standalone”
- Section 2.5 “800 Series 1+1 System”
- Section 2.6 “Adding an 800 +1 Unit to an Existing Standalone; Creating an 800 series 1+1 System”
- Section 2.7 “Verifying the LED Status Indications”
- Section 2.8 “Powering Down”



2.1

Package Contents

Depending on your system requirements, you may receive one or more of the following items:

- Section 2.1.1 “800 Series Standalone Package Contents” on page 6.
- Section 2.1.2 “800 Series +1 System Package Contents” on page 7.

The contents of these devices are described in the following sections.

2.1.1

800 Series Standalone Package Contents

TMG800, TSG800, TMGIP800

In the box, you will find the following items:

- One 800 series unit:
TMG800, TSG800, or TMGIP800. See figure 1.1 on page 2.
- One set of mounting brackets and screws, used to mount the 800 series unit to a 19" rack.
- One Tmedia serial adapter to interface the serial port of your computer with the RJ-45 port of the 800 series unit.
- Three CAT5 Ethernet straight cables (male-male), 3 meters in length.
- One Important Notice (two-sided document containing pertinent product serial numbers, and other important information).
- One Product Warranty.
- One packing slip.
- One Quick Installation Guide (two-sided document that provides a pictorial view of the equipment setup).
- For AC powered units: One or two AC power cables
- For DC powered units: One or two DC power cables

Not included

- A 19" equipment rack. The 800 series unit must be installed on a 19" wide equipment rack.

2.1.2 800 Series +1 System Package Contents

TMG800, TSG800, TMGIP800

In the box, you will find the following items:

- One 800 series unit:
TMG800, TSG800, or TMGIP800. See figure 1.1 on page 2.
- One set of mounting brackets and screws, used to mount the 800 series unit to a 19" rack.
- One Tmedia serial adapter, to interface the serial port of your computer with the RJ-45 port of the 800 series unit.
- Three CAT5 Ethernet straight cables (male-male), 3 meters in length.
- One Important Notice (two-sided document containing pertinent product serial numbers, and other important information).
- One Product Warranty.
- One packing slip.
- One Quick Installation Guide (two-sided document that provides pictorial view of the equipment set-up).
- For AC powered units: One or two AC power cables
- For DC powered units: One or two DC power cables

Not included

- A 19" equipment rack. The 800 series unit must be installed in a standard 19" wide equipment rack.

TMG800 +1, TSG800 +1, TMGIP800 +1

- One 800+1 series unit. See figure 1.1 on page 2.
- One set of mounting brackets and screws, used to mount the 800+1 series unit to a 19" rack.
- One Tmedia serial adapter, to interface the serial port of your computer with the RJ-45 port of the 800 series +1.
- Three CAT5 Ethernet straight cables (male-male), 3 meters in length.
- One Important Notice (two-sided document containing pertinent product serial numbers, and other important information).
- One Product Warranty.
- One packing slip.
- One Quick Installation Guide (two-sided document that provides pictorial view of the equipment set-up).
- For AC powered units: One or two AC power cables
- For DC powered units: One or two DC power cables
- The associated 1+1 patch panel. See Table 2.1, "1+1 Patch Panels", on page 8 for further details.



Not included:

- A 19" equipment rack. The 800 series +1 unit must be installed in a standard 19" wide equipment rack.



1+1 Patch Panel

A 1+1 patch panel is required for the proper connection of the 800 series 1+1 system and is automatically included when a 800 series +1 unit is ordered.

Cables provided: You will be provided with 16 RJ48C cables (yellow), two meters in length with your 1+1 Patch Panel (8 T1/E1).

Table 2.1 1+1 Patch Panels

<p>1+1 Patch Panel (8/T1/E1)</p>	<p>Provides connection for up to 8 T1/E1 lines from the network to the 1+1 Patch Panel (8 T1/E1) and then links to the TMG800/TSG800 and TMG800 +1/TSG800 +1</p> <p>Cables provided:</p> <p>You will be provided with 16 RJ48C cables (yellow), two meters in length, per 1+1 Patch Panel (8 T1/E1) you receive.</p>
----------------------------------	--

2.2 Rack Mounting the 800 Series Standalone or the 800 Series 1+1 System



The 800 series equipment is mounted on a customer provided equipment rack using the mounting hardware packaged in the box.

2.2.1 Prerequisites

To rack mount the equipment, you will need:

- One 19" customer-provided equipment rack. The rack must be solidly anchored to the floor with appropriate support at the top of the racks.
- Climate controlled room: 0 to +50 Celsius, 0 to 95% non-condensing humidity.

2.2.2 Vertical Placement of the Equipment

The 800 series standalone, 800 series +1, and 1+1 Patch Panel are each housed in a 1U chassis, as tabulated in table 2.2 on page 9. It is important that you provide for enough room on the equipment rack to allow for the installation of the equipment.

Consider the available space on your equipment rack and the height of the 800 series gateway equipment. Due to the rear-exhaust heat vents and the efficient heat dissipation design, there is no need to leave any physical vertical space above or below the 800 series gateway equipment on the equipment rack.

Table 2.2 800 Series Gateway Physical Height

Model Number	Vertical Height
800 series standalone	1U (1.75 inches or 44.45 mm)
800 series +1	1U (1.75 inches or 44.45 mm)
Patch Panel	1U (1.75 inches or 44.45 mm)



2.2.3

Installing the 800 Series Standalone and the 800 Series 1+1 on an Equipment Rack

Both the 800 series standalone and the 800 series 1+1 system are mounted on the 19" equipment rack using the angle brackets and screws provided in the box.



Mounting the 800 Series Standalone:

1. Using four metal screws, attach one angle bracket to the front, left-hand side of the 800 series unit, when viewed from the front, as shown in figure 2.1 on page 11. Do the same for the angle bracket on the right-hand side.
2. Start mounting equipment at the top-most position of the rack, keeping in mind the space required on the equipment rack as described in Section 2.2.2 "Vertical Placement of the Equipment" on page 9.



Mounting the 800 Series 1+1 System:

1. Mount the 800 series unit as mentioned above.
2. Install the 800 series +1 unit below the 800 series unit, as shown in figure 2.1 on page 11.
3. To attach the 800 series +1 unit to the equipment rack, follow the previous procedure.
4. Install the patch panel below the 800 series +1 unit, as shown in figure 2.1 on page 11.

800 Series Standalone

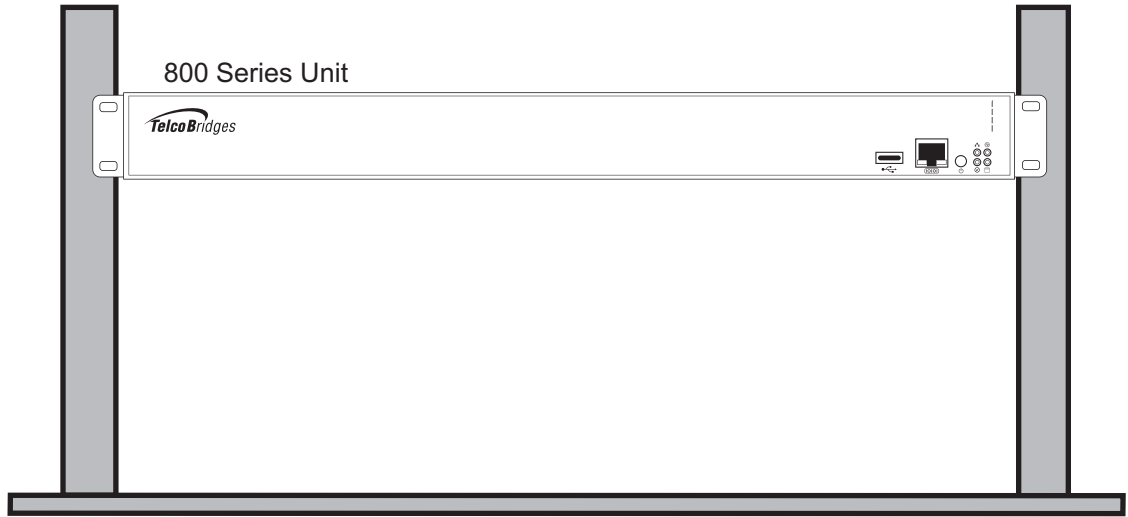

800 Series 1+1 System

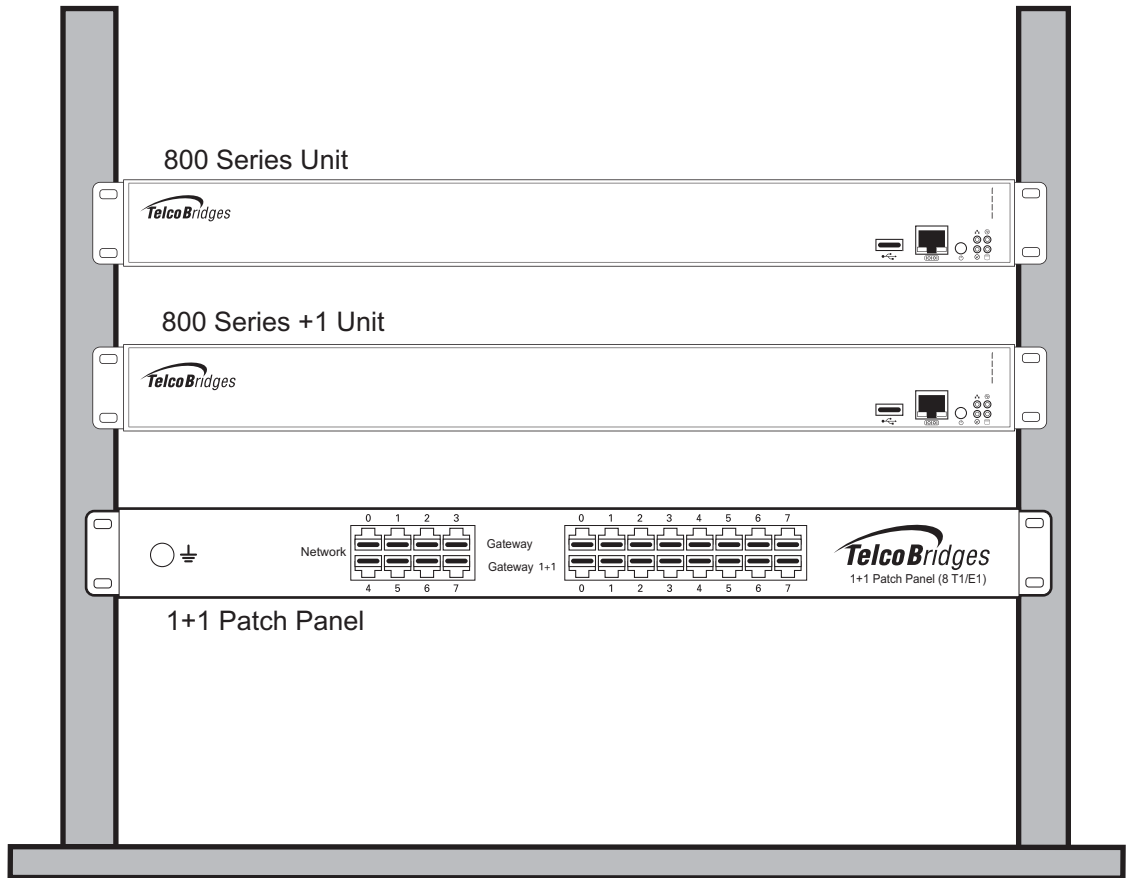

Figure 2.1 Rack Mounting the Equipment



2.3

Choosing your Connection Procedures

Use the following diagram to guide you to the appropriate section, based on your chosen installation.

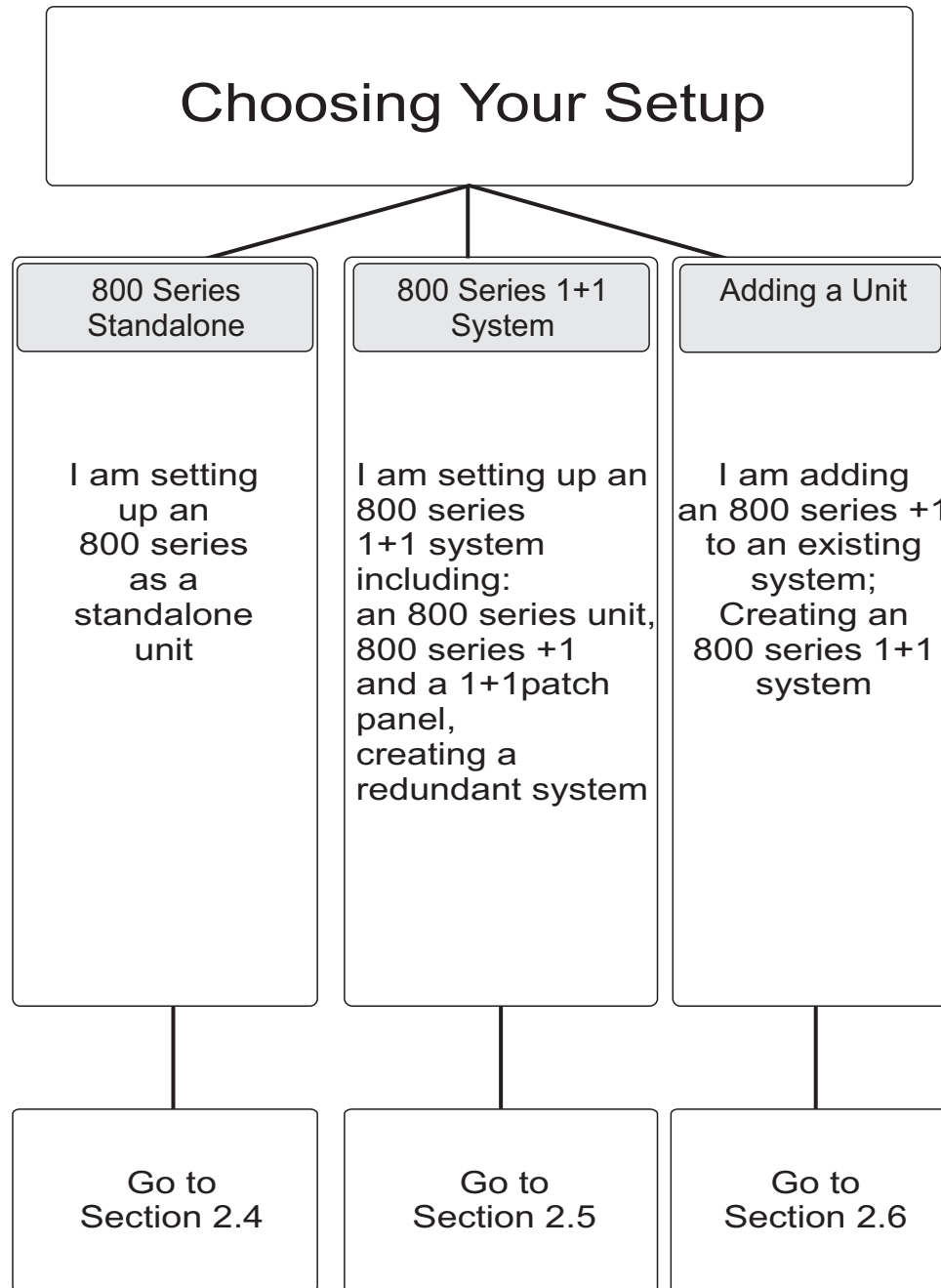

2.4 800 Series Standalone



If you are here, you have a 800 series unit that you will set up as a standalone system. This section covers the following procedures:

- Section 2.4.1 “Connecting to the 800 Series Gateway Management Interface”.
- Section 2.4.2 “Connecting to a VoIP Network”.
- Section 2.4.3 “Connecting to the PSTN”.
- Section 2.4.4 “Powering Up”.
- Section 2.4.5 “Start Up”.



2.4.1

Connecting to the 800 Series Gateway Management Interface

The 800 series gateway management Interface enables administrators to perform management tasks on the 800 series unit.

Prerequisites

To communicate with the management interface, the following is needed:

- One CAT5 Ethernet cable with RJ45 male-male terminations.

Interconnections

The 800 series gateway provides a management interface using one gigabit ethernet network link, as shown in figure 2.2 on page 14.

To communicate with the management interface:

1. Connect the supplied CAT5 ethernet cable to the port labelled "MGMT0" at the rear of the 800 series gateway.

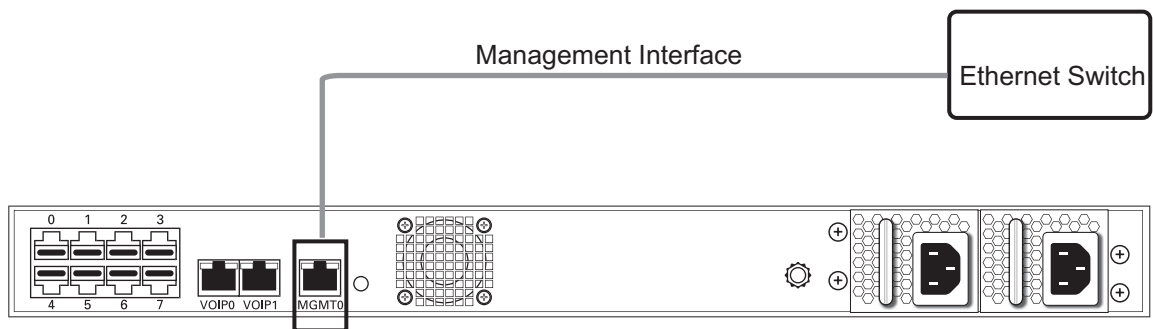

Figure 2.2

Management Interface

2.4.2 Connecting to a VoIP Network



The 800 series gateway features dual GigE ports for connection to different VoIP networks. This provides an access point to manage VoIP traffic. Should one of the IP networks fail, the 800 series gateway will continue to manage VoIP traffic using the alternate network.

The IP address of the VoIP ports can be modified using the web portal.

Note: Certain configurations of the 800 series gateway will exceed 100 Mbps, therefore 1000 Mbps is recommended.

Prerequisites

To connect the 800 series gateway to the VoIP network, you will need:

- Gigabit layer 2 ethernet switch. A second one is required to support redundancy of the VoIP interface.
- One or two CAT5 ethernet cables with RJ45 male-male terminations.
- If your system has access to a second VoIP network, you can connect it to a second VoIP interface of the 800 series gateway with an RJ45 (male-male) CAT5 Ethernet cable.

Connectionse

The 800 series gateway is connected to the VoIP network by one or optionally two ethernet GigE network links, as shown in figure 2.3 on page 15.

To connect the 800 series unit to the VoIP network:

1. Connect a CAT5 Ethernet cable to VoIP0 at the rear of the 800 series gateway. Connect the other end of the same CAT5 cable to the gigabit ethernet switch.
2. If your system employs a second Gigabit Ethernet switch for redundancy, connect a second CAT5 Ethernet cable to VoIP1 at the rear of the 800 series gateway. Connect the other end of the same CAT5 cable to the second gigabit ethernet switch.

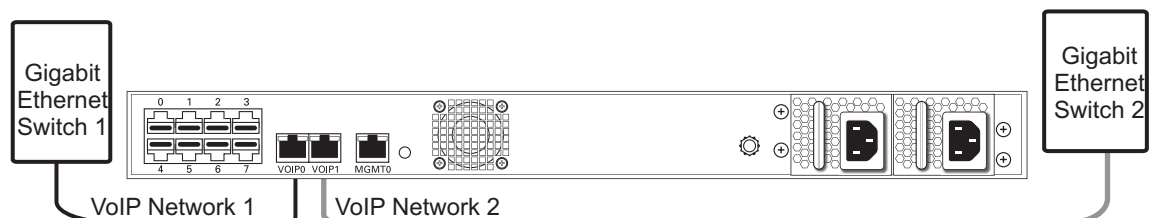

Figure 2.3 Connecting to the VoIP Network



2.4.3

Connecting to the PSTN

Note This section only applies to the TMG800 and TSG800 systems.

A TMG800 or TSG800 with 8 RJ48C type ports enables the connection to T1/E1 lines. The termination impedance is set at 100 ohms for T1 lines and 120 ohms for E1 lines. It is possible to connect an external balun in order to convert the line impedance to 75 ohms.

If you are making your own cables, refer to Section A.1 “RJ48C Wiring Diagram: Crossover and Straight Cables” on page 48 for crossover or straight cable wiring connections.

Note All ports may not be active. T1/E1 ports are activated by software license; the number of active ports depends on the licenses purchased.

To connect to the PSTN:

1. Start with port 0 located at the top and leftmost position. Connect one cable between this port and the T1/E1 line. See figure 2.4 on page 16.
2. Repeat step 1, using the next available port.



Figure 2.4

8-Port Interface to the PSTN



2.4.4 Powering Up

The 800 series gateway is furnished with one (1) or two (2) AC or DC power connections. Only once all other equipment installation work has been completed should the 800 series gateway be powered up.

2.4.4.1 Connecting to AC Power

Prerequisites

To power the 800 series gateway, you will need:

- One to two power sources.
- One or two power cables for the 800 series gateway.

To connect to AC Power:

1. Connect an AC power cable to each AC connector of the 800 series gateway and an AC supply. See figure 2.5 on page 17.

Note If the 800 series gateway features redundant power supplies, it is important to connect both power supplies in order to avoid setting off its audible alarm.

Single power supply

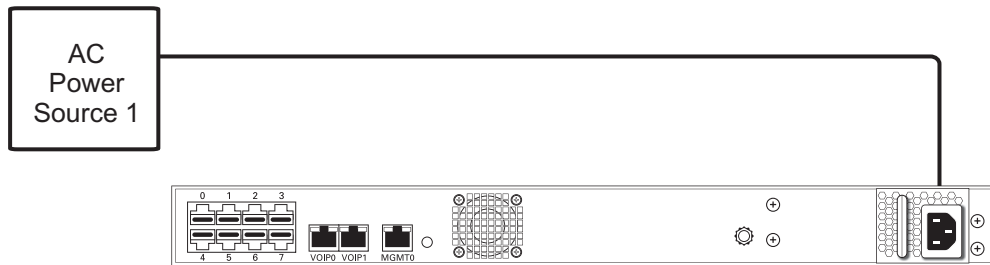

Dual (redundant) power supply

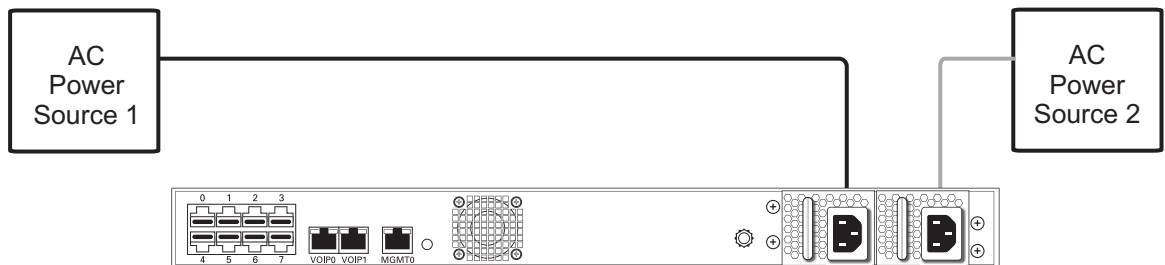

Figure 2.5 AC Power Connection



2.4.4.2

Connecting to DC Power

The 800 series gateway DC model is furnished with one or two power connection ports. In addition, each DC powered unit is supplied with either one or two DC power cables.

To connect to DC power:

Note Two types of cables, with different coloring, are available. Refer to figure 2.6 on page 18 for the appropriate wiring information.

The connection of DC power is described for:

- Single DC power connection port
- Dual DC power connection port

To connect an 800 series gateway with a single DC power supply:

1. Connect a ground wire to the ground plug located at the rear of the unit, as shown in figure 2.6 on page 18.
2. Connect a 14 AWG wire between the positive terminal of a DC power source and the terminal on the unit labelled as $\overset{+}{-}$.
3. Connect a 14 AWG wire between the negative terminal of a DC power source and the terminal on the unit labelled as 48V.

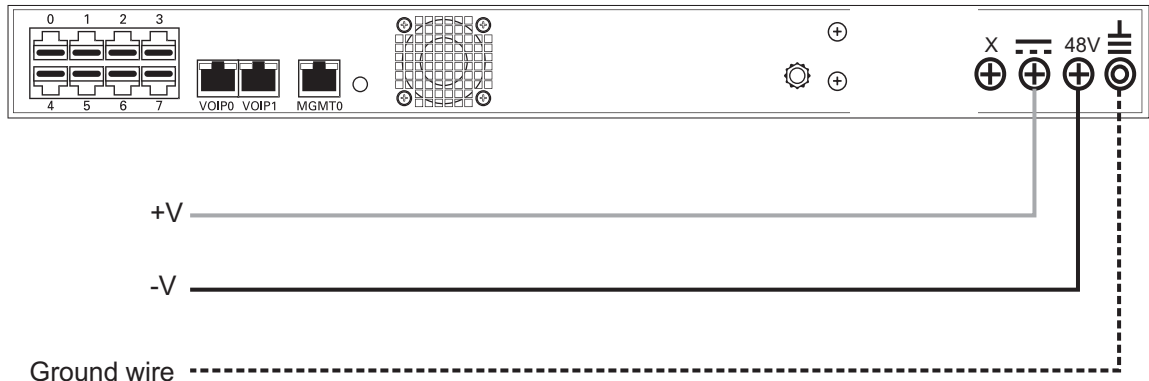

Figure 2.6 800 Series Gateway DC Wiring Diagram



To connect an 800 series gateway with dual (redundant) DC power:

1. Connect one DC cable supplied with the unit, as shown in figure 2.7 on page 19, to the DC outlet at the rear of the unit.

Note Two types of cables, with different coloring, are available. Refer to figure 2.7 on page 19 for the appropriate wiring information.

2. Connect one lead of the DC power cable to the positive terminal of the DC power source, as shown in figure 2.7 on page 19.
3. Connect the other lead of the DC power cable to the negative side of the DC power source.
4. Repeat steps 1-3 for the second power DC power source.

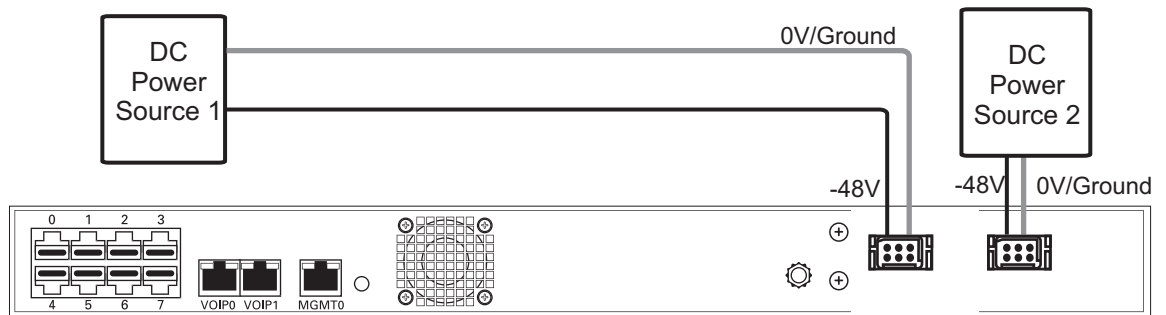

Cable Type	Voltage	
	0v/Ground	-48V
Yellow/Black	Black	Yellow
Red/Black	Red	Black

NOTE:
One of two types of DC power cables are supplied (Black/Red and Yellow/Black)

Figure 2.7 800 Series Gateway Redundant DC Supply Wiring Diagram



2.4.5 Start Up

The first time that you connect to an 800 series gateway, the web portal will appear and you will be asked to select how you would like to configure the 800 series gateway. You will want to be sure to set the role as an 800 series standalone.

Once the configuration settings have been applied, your 800 series gateway will start up and display the web portal configuration management tool.

2.4.5.1 Configuring the Role

To configure the role of your 800 series gateway as a standalone unit, do the following:

1. Connect to the web portal of the standalone unit. The Welcome page appears.

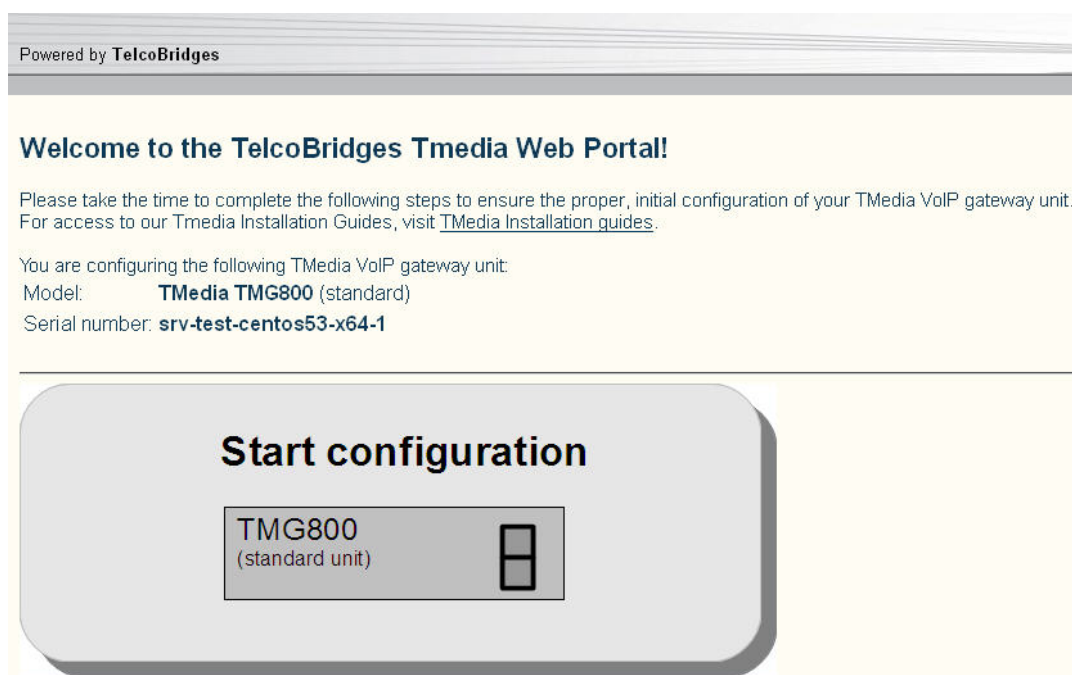

2. Follow the instructions of the web portal to set the role to a standalone gateway.
3. Before clicking the **“yes, it is connected like that already”** button, verify that the physical connections have been properly done.

2.5 800 Series 1+1 System

If you are here, you are installing an 800 series 1+1 system. This section covers the following procedures:

- Section 2.5.1 “Connecting to the 800 Series 1+1 System Management Interfaces”.
- Section 2.5.2 “Connecting to the 800 Series 1+1 System Control Network and VoIP Network(s)”.
- Section 2.5.3 “Connecting to the PSTN in an 800 Series 1+1 System”.
- Section 2.5.4 “Powering Up”.
- Section 2.5.5 “Start Up”.



2.5.1

Connecting to the 800 Series 1+1 System Management Interfaces

The management interface enables administrators to perform management tasks on an 800 series 1+1 system.



Prerequisites

To communicate with the Management Interface, the following is needed:

- Two CAT5 Ethernet cables with RJ45 male-male terminations.

Interconnections

An 800 series 1+1 system provides a management interface for an 800 series and an 800 +1 gateway, each requiring a gigabit ethernet network link. See figure 2.8 on page 22.

To communicate with the management interface:

1. Connect an RJ45 cable from the 800 series gateway to a gigabit ethernet switch.
2. Connect an RJ45 cable from the 800 series +1 gateway to a gigabit ethernet switch.

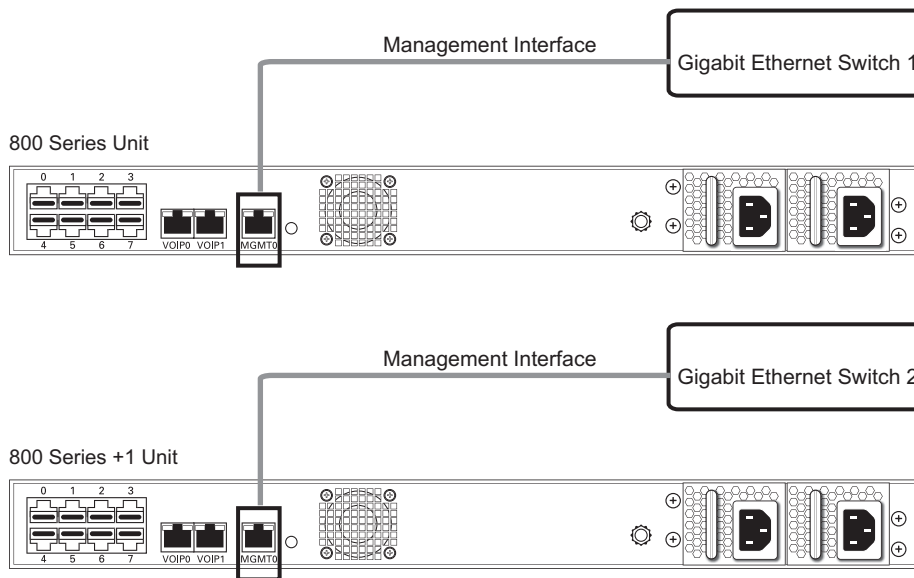

Figure 2.8 Management Interface

2.5.2 Connecting to the 800 Series 1+1 System Control Network and VoIP Network(s)

Each 800 series gateway features dual GigE ports for connection to different VoIP networks. This provides an access point to manage VoIP traffic. Should one of the IP networks fail, the 800 series 1+1 system will continue to manage VoIP traffic using the alternate network. These ports are also used to connect to the 800 series control network, which allows both units to communicate with one another.



The IP address of the VoIP ports can be modified using the web portal.

Note: The 800 series 1+1 system requires two (2) gigabit layer 2 Ethernet switches.

Prerequisites

To connect to the control and VoIP network, you will need:

- Two gigabit layer 2 ethernet switches. A second one is required to support redundancy of the VoIP interface.
- Four CAT5 Ethernet cables with RJ45 male-male terminations.
- Two IP addresses located on different subnets for VoIP.

Connections

The 800 series unit and 800 series +1 VoIP ports must to be connected on both ethernet GigE network links, as shown in figure 2.9 on page 23.

To connect to the VoIP network:

1. Connect the VoIP0 connector from both the 800 series and 800 series +1 units to the first ethernet switch.
2. Connect the VoIP1 connector from both the 800 series and 800 series +1 units to the second ethernet switch.

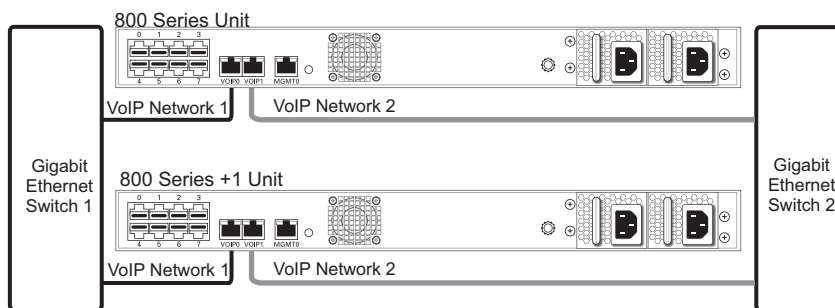

Figure 2.9 Connecting to the 800 Series Control Network and VoIP Network

2.5.3

Connecting to the PSTN in an 800 Series 1+1 System



Note This section only applies to the TMG800 and TSG800 systems.

An 800 series 1+1 system has a TDM interface featuring 8 RJ48C type ports enabling the connection to T1/E1 lines. The termination impedance is set at 100 ohms for T1 lines and 120 ohms for E1 lines. It is possible to connect an external balun in order to convert to 75 ohms. If you are making your own cables, refer to page 48 in Appendix A for crossover or straight cable wiring connections.

Note All ports may not be active. T1/E1 ports are activated by software license; the number of active ports depends on the licenses purchased.

Patch panels use straight connections. In other words, they do not cross the RX and TX signals. Connections between the patch panels and an 800 series 1+1 system require straight cables. The supplied T1/E1 cables are straight cables. Cables used to connect the network to the 1+1 patch panel must do the cross connection.

To connect to the PSTN:

1. Connect T1/E1 lines 0-7 of the Network section of the patch panel to the remote equipment. See figure 2.10 on page 25.
2. Connect T1/E1 lines 0-7 from the 'Gateway' section of the patch panel to the RJ48C connectors of the 800 series unit.
3. Connect T1/E1 lines 0-7 from the 'Gateway 1+1' section of the patch panel to the RJ48C connectors of the 800 series +1 unit.

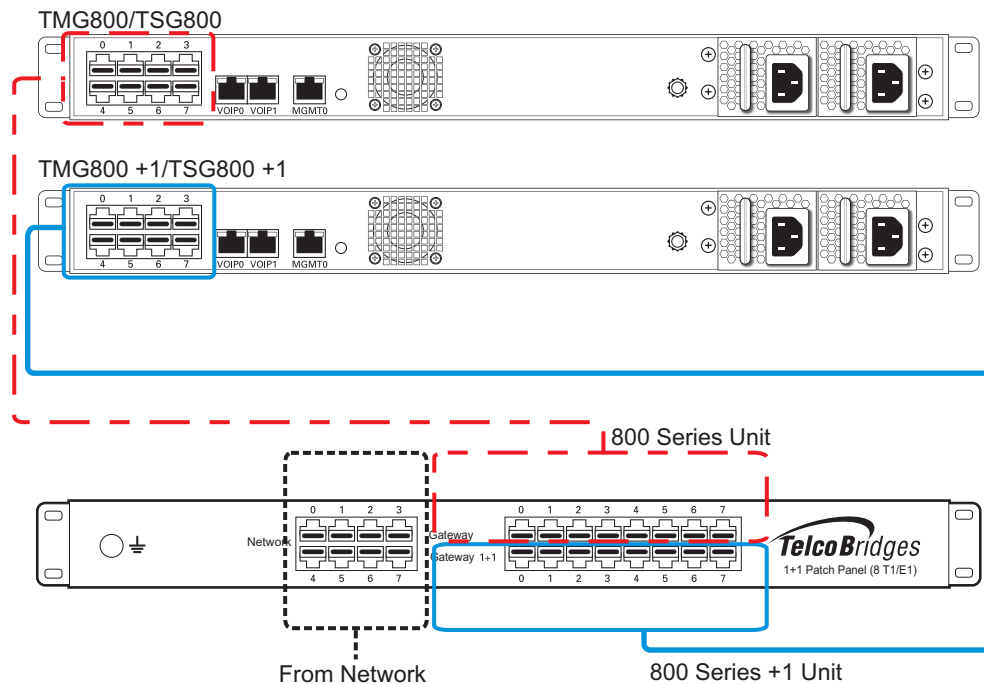

Figure 2.10 TMG800/TSG800 and TMG800 +1/ TSG800 +1 connecting to the 1+1 patch panel (8/T1/E1)

2.5.4 Powering Up



The 800 series and 800 series +1 units are furnished with one (1) or two (2) AC or DC power connections. Only once all other equipment installation work has been completed should the 800 Series 1+1 system be powered up.

Prerequisites

To connect power you will need:

- One to two power sources.
- One or two power cables for every 800 series and 800 series +1 unit.

2.5.4.1 Connecting to AC Power

To connect to AC Power:

1. Connect the first power connector of each unit to the first power source. See Figure 2.11.
2. Connect the second power connector of each unit to the second power source.

800 Series 1+1 System with Single Power Supply

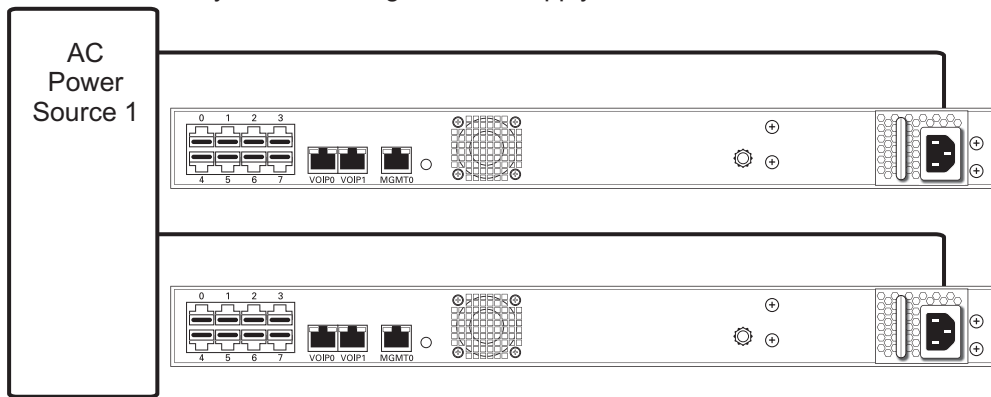

800 Series 1+1 System with Dual Power Supply

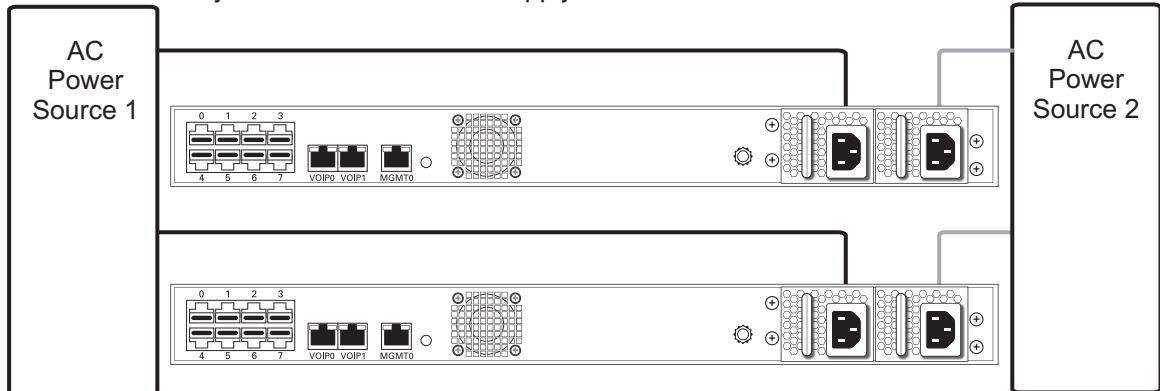

Figure 2.11 800 Series and 800 Series +1 AC Power Connections

2.5.4.2 Connecting to DC Power

The 800 series and 800 series +1 DC models are furnished with either single or redundant DC power connection ports. In addition, each DC powered unit is supplied with one or two DC power cables.



To power an 800 series unit with a single DC power supply:

1. Connect a ground wire to the ground plug, located at the rear of the unit, as shown in figure 2.6 on page 18.
2. Connect a 14 AWG wire between the positive terminal of a DC power source and the terminal on the unit labelled as .
3. Connect a 14 AWG wire between the negative terminal of a DC power source and the terminal on the unit labelled as 48V.

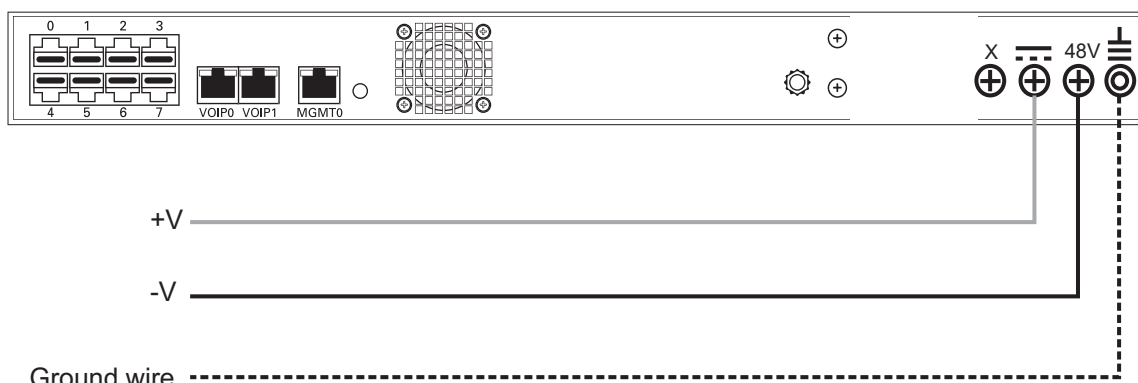

Figure 2.12 800 Series Unit DC Wiring Diagram

To connect an 800 Series and 800 Series +1 Units to DC Power

1. Connect the first DC power connector of the 800 series and 800 series +1 units to a DC power source one. See figure 2.13 on page 28.
 - 1a. Connect one lead of each DC power cable to the positive terminal of the DC power source.
 - 1b. Connect the other lead of each DC power cable to the negative side of the DC power source.
2. Repeat the previous steps for the second DC power source.

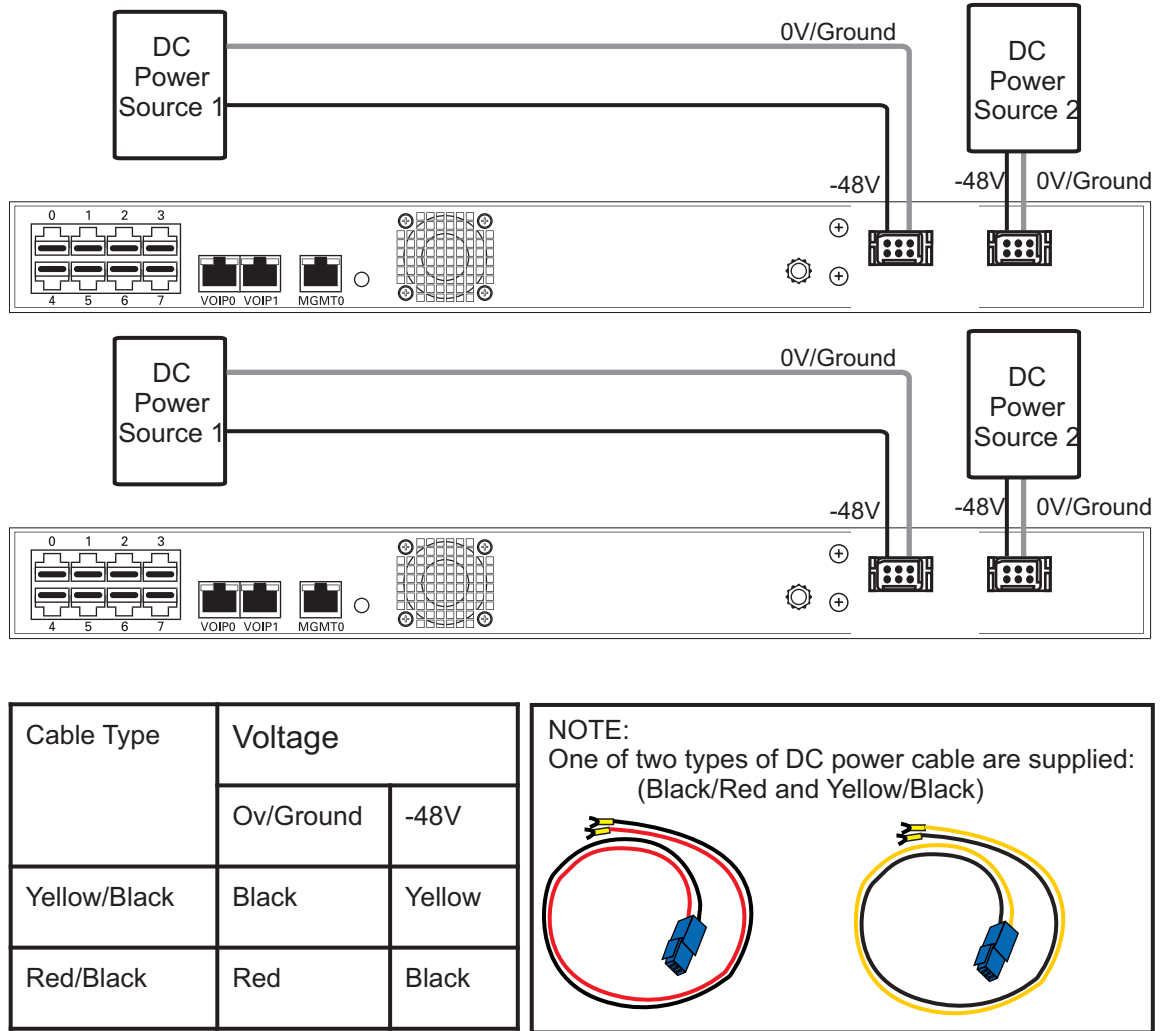

Figure 2.13 800 Series and 800 Series +1 DC Power Connections

2.5.5 Start Up

After powering up the 800 series 1+1 system, you must configure both units, one as primary and the other as secondary.

Once these configuration settings have been applied, your 800 series 1+1 system will start up and display the web portal configuration management tool.

1. Connect to the web portal. The Welcome page appears.



Note: The Welcome page indicates whether the 800 series unit is a primary or secondary.

2. Follow the instruction of the web portal to configure your units as a new 800 series 1+1 system.
3. For VLAN configuration and connection, 2 VLANs are required for the 800 series control network. Both gigabyte layer 2 ethernet switches **MUST** have their VLANs configured and the 800 series equipment must be properly connected **BEFORE** proceeding. The default VLAN IDs are:
 - ETH0: 710
 - ETH1: 711

Once you are ready, click **Save** to configure the VLANs.





Designating your VLAN Ids for your Tmedia 1+1 System

Each Tmedia TMG800 1+1 System requires two (2) VLAN to ensure redundant control networks. The VLANs (control networks) are used to allow the two units in your 1+1 system to communicate with each other during operation.

Proper connection

For the configuration of your system, it is extremely important to ensure the proper physical connection of your telecom units to redundant Ethernet switches as detailed below:

1. Connect voip0 of your TMG800 & TMG800+1 to Ethernet switch A
2. Connect voip1 of your TMG800 & TMG800+1 to Ethernet switch B
3. Create a VLAN, on switch A, only between the two ports connected to the Tmedia units
4. Create a VLAN, on switch B, only between the two ports connected to the Tmedia units

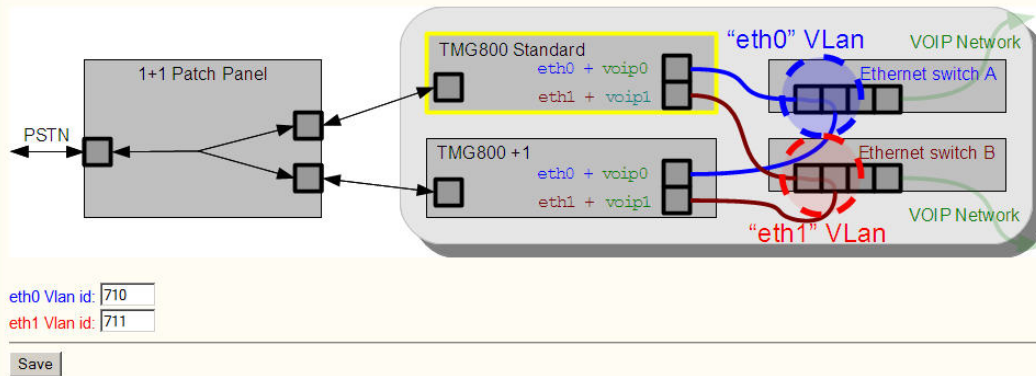

The progress page is displayed.

Configuration is now in progress...

Configuration may take several minutes (up to ~3 minutes)
It may be impossible to refresh this web page at some point during that period.

If after the elapsed time you do not see any progress, please cancel the configuration to start again.

2.6 Adding an 800 +1 Unit to an Existing Standalone; Creating an 800 series 1+1 System

Warning: This procedure will require some system downtime.



In order to add an 800 series +1 unit to an 800 series standalone unit, you must perform the following procedures:

- Section 2.6.1 “Reconfigure a Standalone Unit as a Primary Unit in an 800 Series 1+1 System”
- Section 2.6.2 “Install the 800 Series +1 unit on the Equipment Rack”
- Section 2.6.4 “Connect to the 800 Series 1+1 Management Interface”
- Section 2.6.6 “Connect to the PSTN Network”
- Section 2.6.7 “Power Up the Equipment”
- Section 2.6.8 “Start Up”

2.6.1 Reconfigure a Standalone Unit as a Primary Unit in an 800 Series 1+1 System

1. Connect to the web portal of the standalone 800 series unit.
2. Select **Status** from the navigation panel.
3. Select the **Hosts** status tab.

System		Hardware	1+1	Hosts	Applications
Isdn	Iua	Casr2	Sip	Clock	TMS Nap
Hosts					
name	value				
Ready cnt	1				
Not ready cnt	0				
Disk full cnt	0				
Fack recommended cnt	0				
Fack required cnt	0				
Ready host list	TB005577				
Not ready host list					
Disk full host list					
Fack required host list					
Fack recommended host list					

4. Select **ResetHostRole** for the action, and click **Apply Action**.



Host Status - TB005577

Status Options

Refresh every:

Extended status

Host | Processor Usage | Memory Usage | Filesystem Usage | Network Interfaces

Name	Value
Host	TB005577
Host role	Standalone
Can move	Master
Can start	Ready
High fail	Yes
Host platform	TM0020 CentOS
Host platform	ipr6_644xv84_centos5
Last lock	Tue Oct 18 18:07:53 2011
Fack status	No filesystem check required yet

Host Control

Action

Current Action Log

Last Action Log

```

VlanManagementReq: Starting
VlanManagementReq: Script completed successfully
VlanManagementReq: Done
    
```

5. Connect to the web portal. The Welcome page appears.

Welcome to the TelcoBridges Tmedia Web Portal!

Please take the time to complete the following steps to ensure the proper, initial configuration of your TMedia VoIP gateway unit. For access to our Tmedia Installation Guides, visit [TMedia installation guides](#).

You are configuring the following TMedia VoIP gateway unit:

Model: **TMedia TMG800** (standard)

Serial number: **srv-test-centos53-x64-1**

Start configuration

TMG800
(standard unit)

Note: The Welcome page indicates whether the 800 series unit is a primary or secondary unit.

6. Follow the instruction of the web portal to configure your unit as a primary unit in a new 800 series 1+1 system.

- For Vlan configuration and connection, the 800 series 1+1 system requires 2 VLANs for the 800 series control network. Both gigabyte layer 2 Ethernet switches MUST have their VLANs configured and the 800 series gateway must be properly connected BEFORE proceeding. The default VLAN IDs are:

- ETH0: 710
- ETH1: 711

Once you are ready, click **Save** to configure the VLANs.



Designating your VLAN Ids for your Tmedia 1+1 System

Each Tmedia TMG800 1+1 System requires two (2) VLAN to ensure redundant control networks. The VLANs (control networks) are used to allow the two units in your 1+1 system to communicate with each other during operation.

Proper connection

For the configuration of your system, it is extremely important to ensure the proper physical connection of your telecom units to redundant Ethernet switches as detailed below:

1. Connect voip0 of your TMG800 & TMG800+1 to Ethernet switch A
2. Connect voip1 of your TMG800 & TMG800+1 to Ethernet switch B
3. Create a VLAN, on switch A, only between the two ports connected to the Tmedia units
4. Create a VLAN, on switch B, only between the two ports connected to the Tmedia units



eth0 Vlan id:
 eth1 Vlan id:

The progress page is displayed.

Configuration is now in progress...

Configuration may take several minutes (up to ~3 minutes)
 It may be impossible to refresh this web page at some point during that period.

If after the elapsed time you do not see any progress, please cancel the configuration to start again.

2.6.2 Install the 800 Series +1 unit on the Equipment Rack

The 800 series +1 unit is mounted on a customer provided equipment rack using the mounting hardware packaged in the box. Refer to Section 2.2 “Rack Mounting the 800 Series Standalone or the 800 Series 1+1 System” on page 9.



2.6.3 Install the 1+1 Patch Panel

If you are installing an 800 series +1 unit, the associated 1+1 Patch Panel will look like the image to the right. Refer to Section 2.4.3 “Connecting to the PSTN” on page 16.

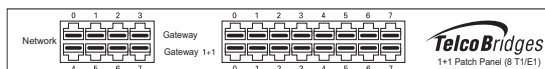

2.6.4 Connect to the 800 Series 1+1 Management Interface

The 800 series management interface enables administrators to perform management tasks on the 800 series equipment.

Follow the procedure described in Section “To connect to the PSTN:” on page 24.

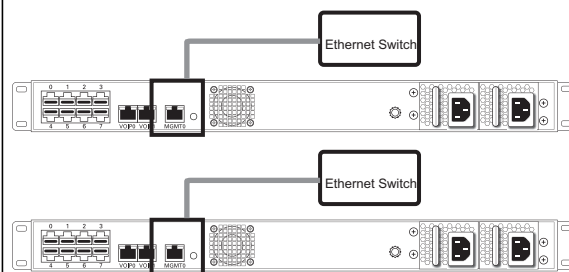

2.6.5 Connect to the 800 Series 1+1 Control Network and VoIP Network(s)

The 800 series and 800 series +1 units feature dual GigE ports for connection to different VoIP networks. This provides an access point to manage VoIP traffic. Should one of the IP networks fail, the 800 series 1+1 system will continue to manage VoIP traffic using the alternate network. These ports are also used to connect to the 800 series control network, which allows both units to communicate with each another.

Follow the procedure described in Section 2.5.2 “Connecting to the 800 Series 1+1 System Control Network and VoIP Network(s)” on page 23.

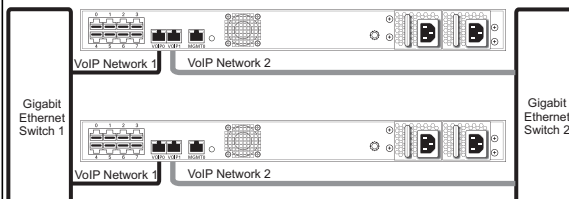

2.6.6 Connect to the PSTN Network

Note This section only applies to the TMG800 and TSG800

The 800 series gateways feature 8 T1/E1 interfaces for connection to the PSTN network.

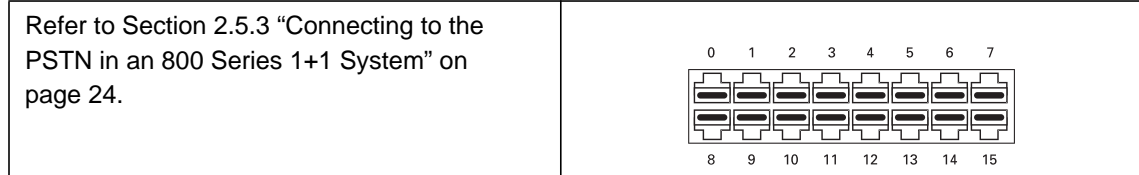

2.6.7 Power Up the Equipment

The 800 series and 800 series +1 units are furnished with one (1) or two (2) AC or DC power connections. Only once all other equipment installation work has been completed should the 800 series 1+1 system be powered up. Refer to Section 2.5.4 “Powering Up” on page 26.





2.6.8

Start Up

1. Connect to the web portal of the 800 series 1+1 system. The Welcome page appears.



2. For Vlan configuration and connection, the 800 series 1+1 system requires 2 VLANs for the 800 series control network. Both gigabyte layer 2 Ethernet switches **MUST** have their VLANs configured and the 800 series gateway must be properly connected **BEFORE** proceeding. The default VLAN IDs are:

- ETH0: 710
- ETH1: 711

Once you are ready, click **Save** to configure the VLANs.

3. Click **Yes** to configure the Vlans

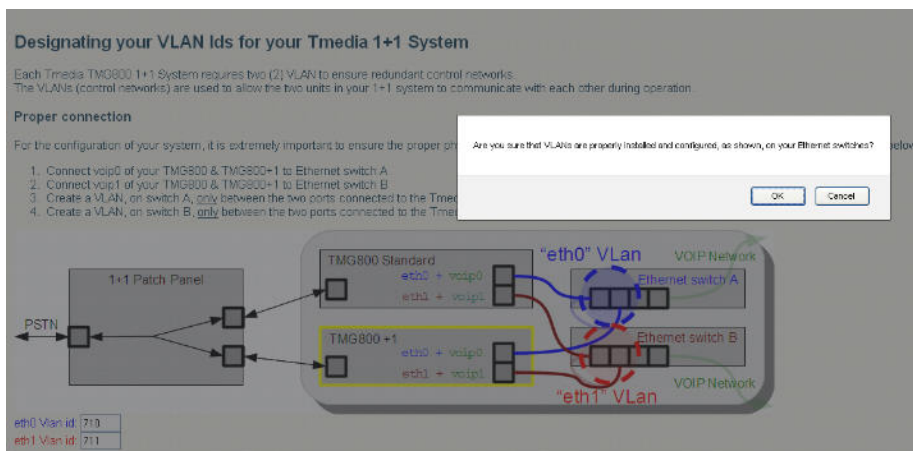

2.7 Verifying the LED Status Indications



Front of Unit

When the equipment is powered, verify the front panel to determine that all indications are normal. See Table 2.3 on page 37.

Table 2.3 800 Series Unit Displays

LED	Description
	<ul style="list-style-type: none"> Unused
	<ul style="list-style-type: none"> Off: Not Ready Flashing Red: Unit has failed during the boot up process. Flashing Orange: The unit will shut down in a few minutes. Flashing Green: The unit is performing a boot up. Steady Green: The unit has successfully performed a boot up.
	<ul style="list-style-type: none"> Off: Unpowered Steady Red: Initial Startup sequence Steady Green: Powered
	<ul style="list-style-type: none"> Off: No hard drive activity Steady Green: Read/Write activity on the hard drive.

Note An alarm will sound if one of the power supplies is faulty. There is no alarm button to disable the alarm. To stop the alarm, you must remove the faulty power supply.

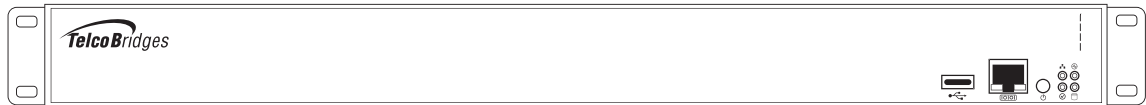

Figure 2.14 Front display and LEDs



2.8

Powering Down

Powering down the 800 series 1+1 requires you to connect to the management interface using SSH, and enter:



```
shutdown -hP now
```

Attention DO NOT TURN OFF the power to the 800 series gateway using the power switch located at the rear of the unit, unless you have already performed the previously mentioned shut down procedure. Allow enough time for the VoIP gateway to shut down before turning the power off (ex. minimum 1 minute). Be aware that the shutdown procedure of the unit is logged and traceable for support and warranty purposes.

Note For alternative methods to this procedure, refer to Section 2.7 "Verifying the LED Status Indications" on page 37 that describes how to power down using the reset button.



Section 3 Initial System Configuration

This section provides information about the following topics:

- Section 3.1 “Connecting to the Serial Port of the 800 Series Gateway”
- Section 3.2 “Configuring the Terminal Emulator Application”
- Section 3.3 “Connecting to the 800 Series Gateway”
- Section 3.4 “Retrieving 800 Series Gateway Information”
- Section 3.5 “Changing the 800 Series Gateway Management Port IP Address”
- Section 3.6 “Changing 800 Series Gateway Management Port Passwords”
- Section 3.7 “Setting the Time Zone”
- Section 3.8 “Configuring the 800 Series Gateway Using the Web Portal”
- Section 3.9 “Changing VoIP Interface Addresses”



3.1

Connecting to the Serial Port of the 800 Series Gateway



Note By default, the management port is set to DHCP.

Sections 3.1 and 3.2 provide instructions on how to convert the DHCP management port to a static IP address. If your network supports DHCP, skip sections 3.1 and 3.2.

The serial port interface enables administrators to perform management tasks on the 800 series gateway.

To connect to the serial port of an 800 series gateway:

1. Connect one end of a CAT5 RJ-45 (male-male) cable to the Tmedia serial adapter (both supplied with unit). Connect the DB9 to RJ-45 to the serial port of the computer and the other end of the CAT5 RJ-45 (male-male) cable to the serial port (labelled 10101) of the 800 series gateway as shown in figure 3.1 on page 40. See Section A.2 “RJ48 Console Wiring Diagram” on page 48 for a RJ-45 pinout description.
2. If your computer’s serial port features a DB9 connector, use the Tmedia serial adapter supplied with your 800 series gateway. If your computer’s serial port features a USB connector, you will need to provide a USB to DB9 adaptor. Refer to figure 3.2 on page 40.

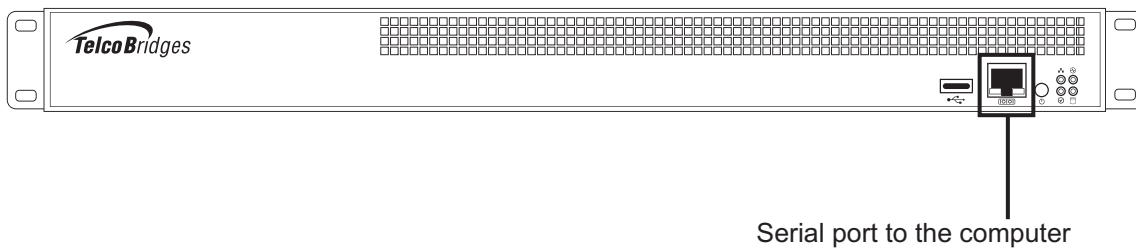

Figure 3.1 Computer to 800 Series Gateway Serial Port Connection

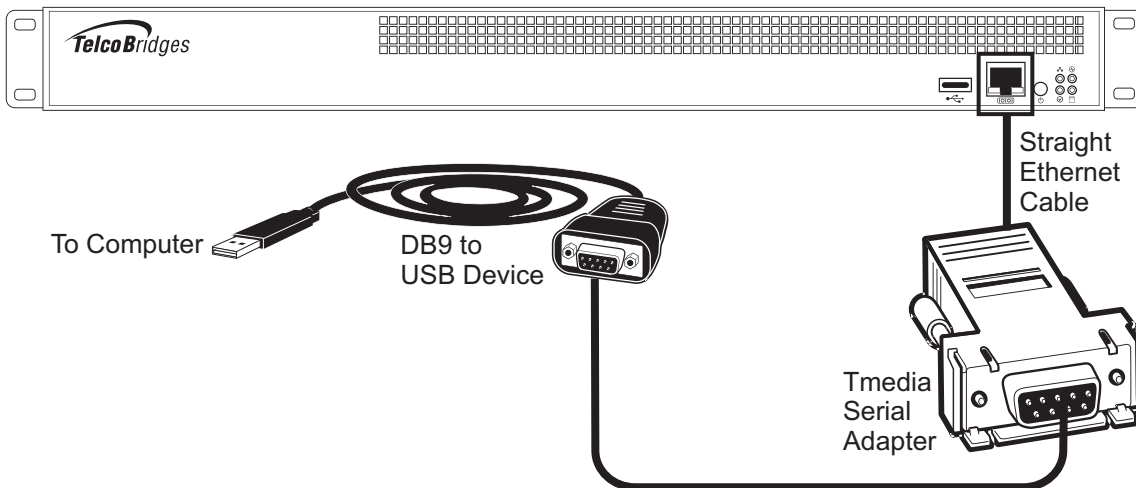

Figure 3.2 Conceptual View of a Serial Connection from the 800 Series Gateway to a Computer

3.2 Configuring the Terminal Emulator Application

Before communicating with the management interface, you must first configure a terminal emulator or console application to communicate with the 800 series system in order to configure initial settings. Available terminal emulation software includes:

- HyperTerminal
- Putty
- Minicom

To configure the terminal emulator application:

1. Set the baud rate (bits per second) to **9600**
2. Set the data rate to **8 bits**
3. Set the parity to **None**
4. Set the stop bits to **1**
5. Set the flow control to **None**

Note See Section 3.5 on page 42 to learn how to change the IP address of the MGMT0 port.

3.3 Connecting to the 800 Series Gateway

The 800 series gateway is shipped with the TMG-CONTROL software preinstalled. In order to make changes to the system configuration, you must connect the port labelled MGMT0 at the rear of the 800 series gateway to a terminal.

To access the 800 series gateway, you must use an SSH connection. The password is set at the factory and is indicated on the shipment sheet.

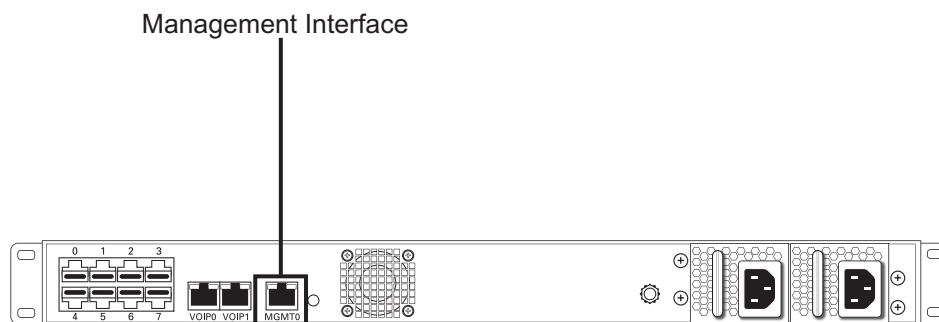

Figure 3.3 800 Series Gateway Management Interface





3.4 Retrieving 800 Series Gateway Information

The 800 series gateway enables you to retrieve system information with the following shell commands:

- `tbproduct` (retrieve the 800 series gateway product type). See http://docs.telcobridges.com/mediawiki/index.php/TMG:Get_Product_Type, for further information.
- `tbserial` (retrieve the 800 series gateway serial number). See http://docs.telcobridges.com/mediawiki/index.php/TMG:Get_Serial_Number, for further information.



3.5 Changing the 800 Series Gateway Management Port IP Address

Note The following procedure must be performed on the 800 series standalone or the 800 series 1+1 system.

The management port of the 800 series gateway (labeled MGMT0) is configured using DHCP by default. It can be modified using the following shell script: `tbchangeip`

3.6 Changing 800 Series Gateway Management Port Passwords

Note The following procedure must be performed on the 800 series standalone unit or the 800 series 1+1 system.

Once logged onto the 800 series gateway, type “`passwd`”, to change the password. The following information will be displayed:

```
[root@TB003540 ~]# passwd
Changing password for user root.
New UNIX password:
Retype new UNIX password:
passwd: all authentication tokens updated successfully.
```

3.7 Setting the Time Zone

Note The following procedure must be performed on the 800 series standalone unit or the 800 series 1+1 system.

You can change the time zone of the 800 series gateway using the `tbtimezone` shell command.

3.8 Configuring the 800 Series Gateway Using the Web Portal



Note: The first time that you connect to the web portal, you will need to configure the role of the 800 series unit.

If your system features an 800 series standalone unit, refer to Section 2.4.5 “Start Up” on page 20.

If your system features an 800 series unit working in conjunction with an 800 series +1, refer to Section 2.5.5 “Start Up” on page 29.

To change the default configuration of an 800 series gateway using the Web Portal, follow the steps described in the Web Portal System Configuration Tutorial Guide, found on the TBWiki:

<http://docs.telcobridges.com>

The Web Portal can be accessed with a Web browser. The default url is: `http://[Tmedia MGMT0 IP address]:12358`

Note The 800 series and 800 series +1 units can access the Web Portal from either one of their IP addresses.

The default login information to access the Web Portal application is:

- Username: root
- Password: root

3.9 Changing VoIP Interface Addresses

The default address of the VoIP interfaces of the 800 series gateway can be modified. To learn how this is done, refer to the Web Portal tutorial guide on the Telcobridges TB Wiki at docs.telcobridges.com.

Note With regard to sections 3.2, 3.3, 3.4 3.5, 3.6 or 3.7, please visit the TBWiki at: <http://docs.telcobridges.com>





Section 4 System Backups

This section provides information about the following topics:

- Section 4.1 “Creating a Database Backup”
- Section 4.2 “Downloading a Database Backup”
- Section 4.3 “Uploading a Database Backup”
- Section 4.4 “Restoring a Database Backup”



For more detailed information with regard to any of the points described in this section, please refer to the TBWiki: <http://docs.telcobridges.com>



4.1 Creating a Database Backup

It is important that backups be made of system configuration settings in the event of a system failure. It is recommended that a backup be made once the system has been configured. Backups are performed using the web portal.

4.2 Downloading a Database Backup

A backup of system data is stored on the hard drive of the 800 series gateway. It is important that system backups be downloaded to an external storage device.

4.3 Uploading a Database Backup

An external backup of your database can be uploaded to your 800 series gateway.

4.4 Restoring a Database Backup

In the event of a system failure requiring the replacement of an 800 series gateway, a previously saved backup of system settings can be restored to the new unit.



Appendix A Wiring Diagrams



A.1

RJ48C Wiring Diagram: Crossover and Straight Cables



RJ48C (T1/E1) Wiring Schematic: Crossover Cable

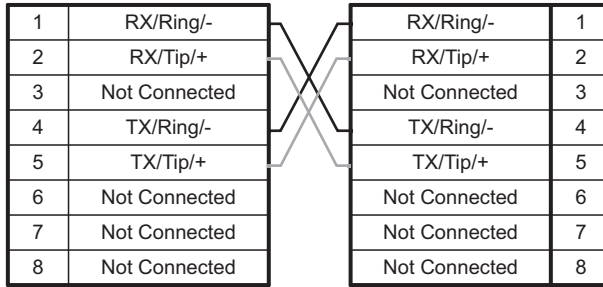

RJ48C (T1/E1) Wiring Schematic: Straight Cable

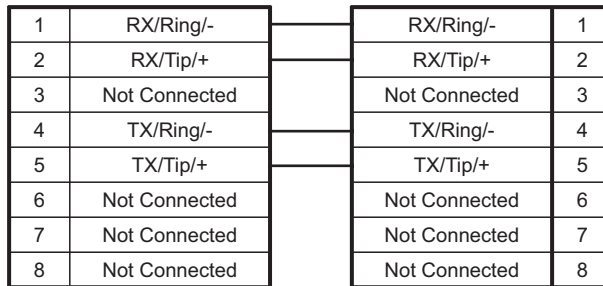

A.2

RJ48 Console Wiring Diagram

