

1

Items not included in this box that you will need:

- Two AC power cords
- 19" equipment rack

2

In the box, you will find:

- One TMG5800
- One set of mounting brackets with screws
- SCSI Cables and Patch Panels, if applicable
- Three RJ45 Ethernet Straight Cables (male-male)
- One warranty sheet
- One packing slip
- One TMG5800 Quick Installation Guide

3

A) Install rack-mounting hardware on TMG5800 and install on equipment rack.

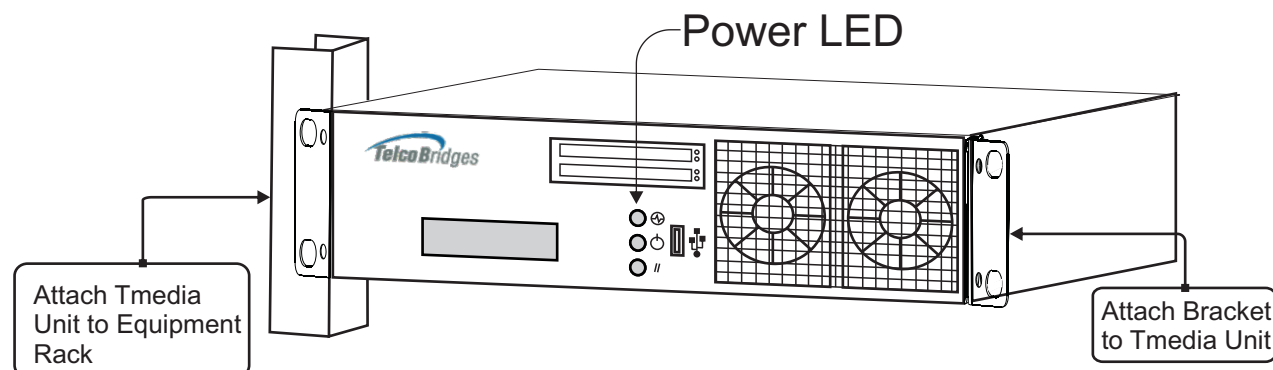

B) Use ETH0 or ETH1 ports to connect to Linux Host.

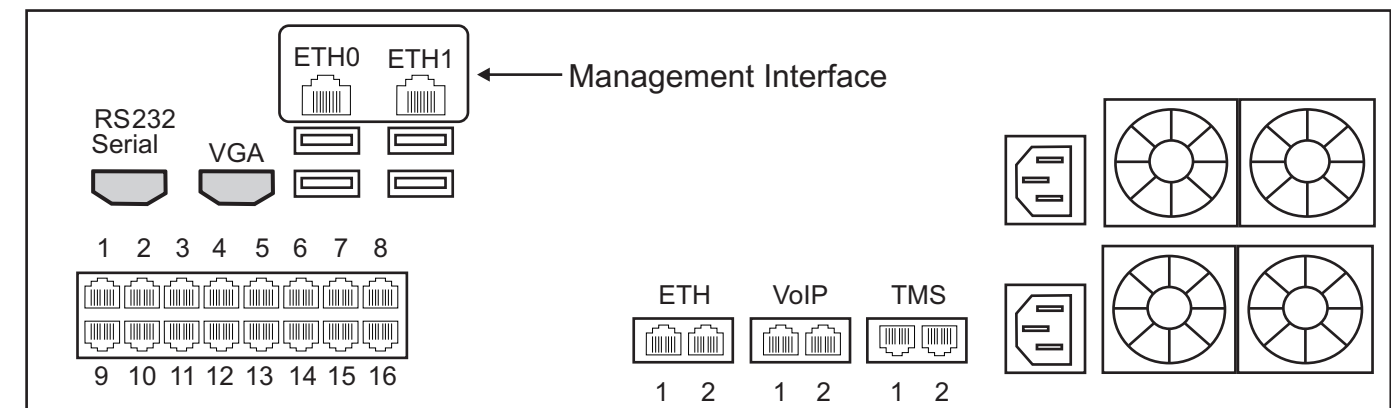

4

Connect to VoIP network.

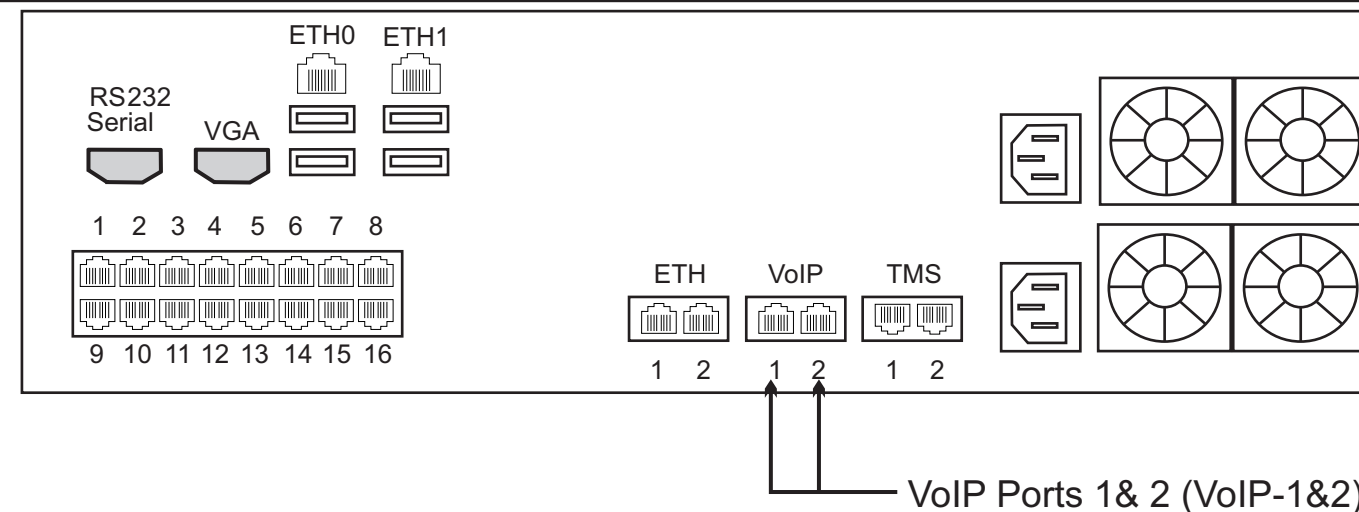

# TMG5800 AC Quick Installation Guide

5

Connect to PSTN Network, using one of the following options:

- RJ-48 Interface (T1/E1/J1)
- SCSI Interface (T1/E1/J1), a patch panel is provided
- Dual BNC (DS3)
- Optical Interface (OC3/STM-1)

## RJ-48

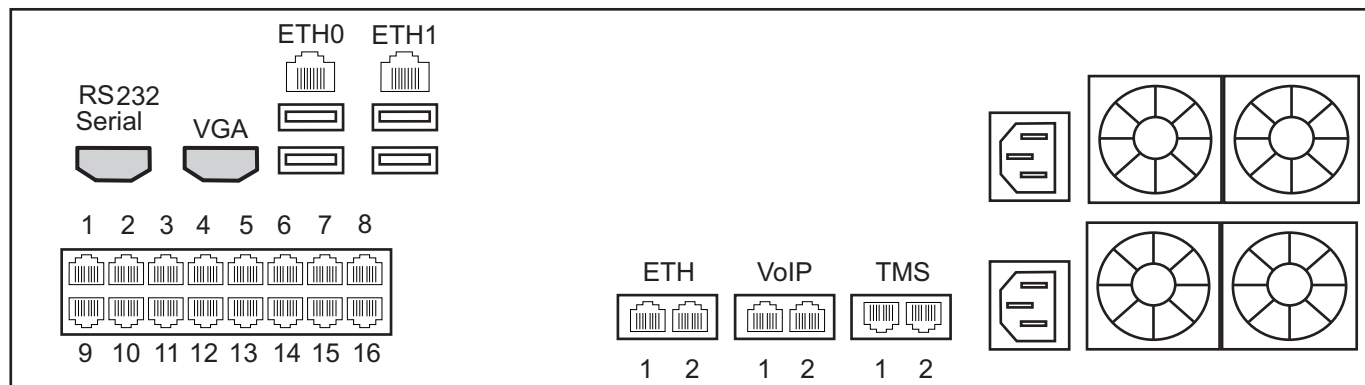

## DS3

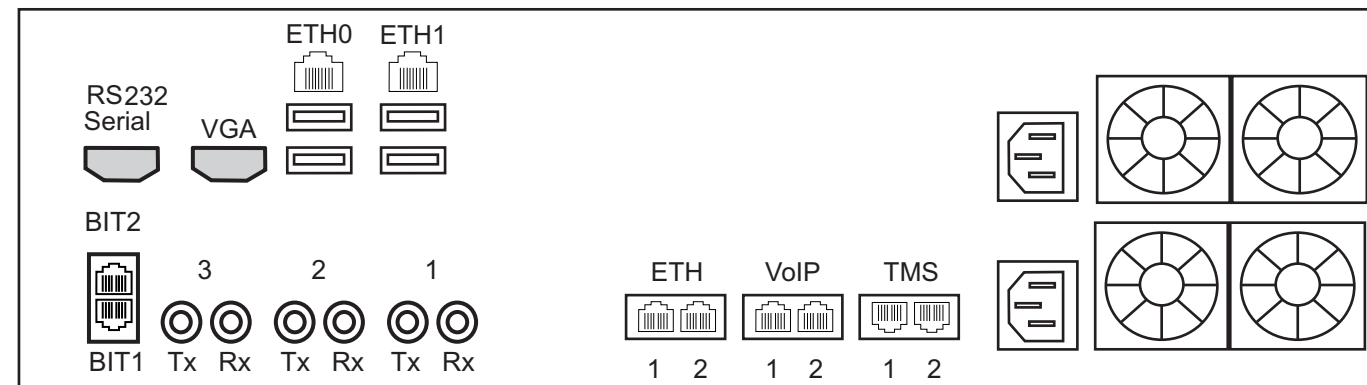

## SCSI

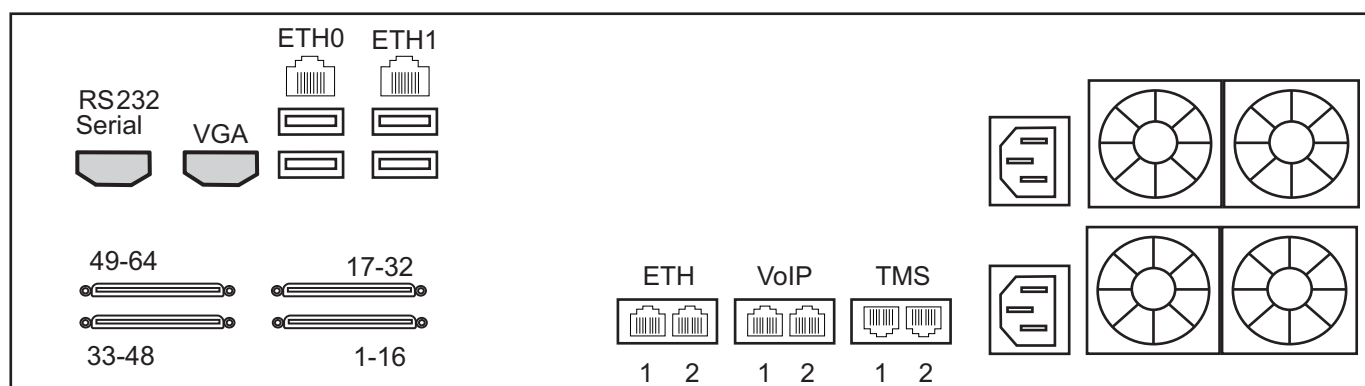

## STM 1

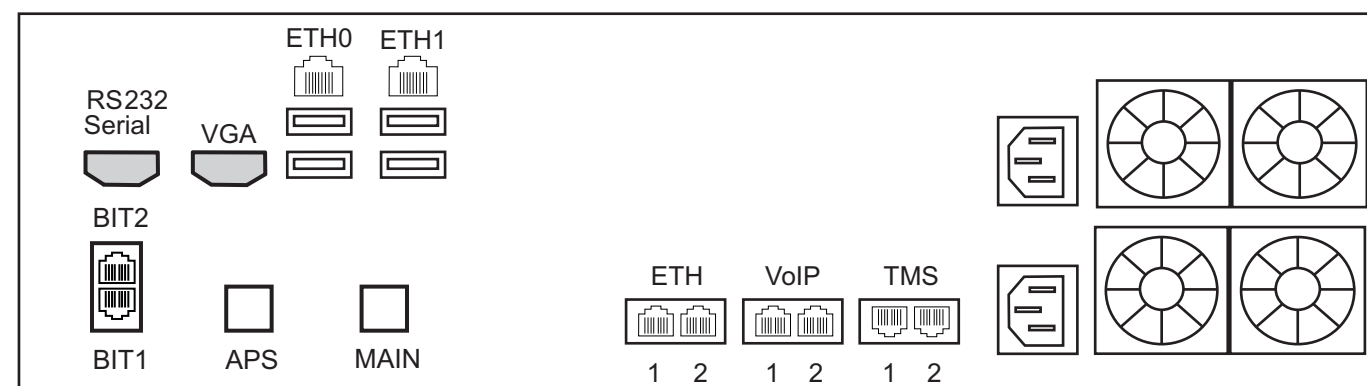

6

- A) Connect to two independent power sources (if only one power source is used, press the green button at the rear of the unit to disable the audible alarm).
- B) Verify Power LED = Solid Green (Refer to Panel 3)

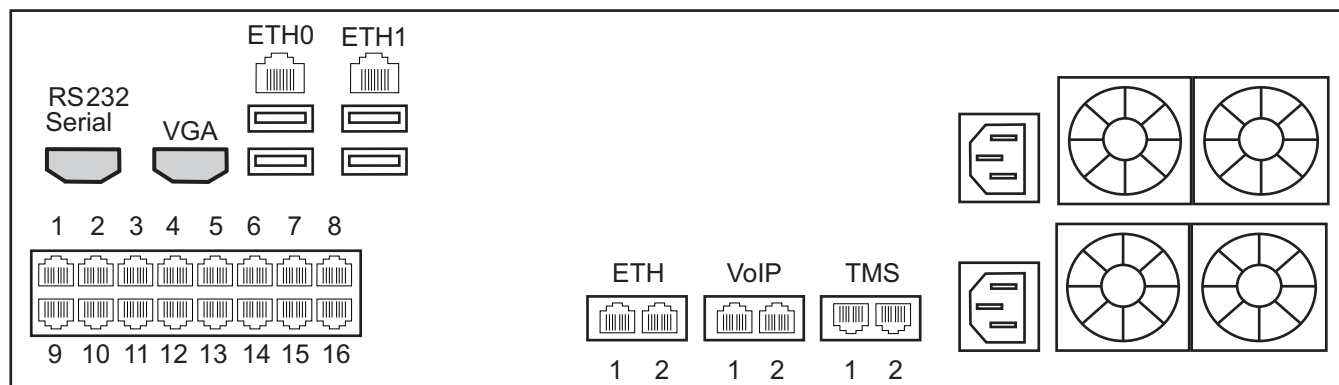

7

- A. Connect to the Linux host through management Ethernet. The IP address of the management port is assigned through DHCP. If DHCP is not available, use the serial cable to connect to the TMG Linux Host for the first time.
- B. Default HOSTNAME is the Linux Host serial number, which can be found in the packing slip.
- C. Default username and password are "root":"root" to log onto the Linux OS. Navigate to: [HTTP://HOSTNAME:12358](http://HOSTNAME:12358), to configure the TMG5800.

Next Steps? More information is available on the TelcoBridges TB Wiki at: <http://docs.telcobridges.com/mediawiki/index.php/TMG5800>