

TelcoBridges

Installation Guide

3200 Series Gateway Standalone & 3200 Series Gateway 1+1

December 2, 2013



The information in this document as well as product specifications referred to throughout, are subject to change without notice. No part of this document may be reproduced or transmitted in any form or by any means, electronic or mechanical, for any purpose, without the express written permission of TelcoBridges. TelcoBridges may have patents or pending patent applications, trademarks, copyrights, or other intellectual property rights covering subject matter in this document. The furnishing of this document does not give you license to these patents, trademarks, copyrights, or other intellectual property except as expressly provided in any written license agreement from TelcoBridges Inc.

The information provided in this document is intended as a guide only. For the latest detailed engineering specifications, please contact TelcoBridges TB Support or visit the TBWiki: <http://docs.telcobridges.com>. TelcoBridges is committed to continually improving product designs; as a result, product specifications may be subject to change without notification.
© 2003-2013 TelcoBridges. All rights reserved.

TelcoBridges, Tmedia, TMG800, TMG3200, TMG3200-RJ, TMG3200-TE, TMG3200-DS3, TMG3200-STM1, TMG7800, TMG7800-TE, TMG7800-DS3, TMG7800-STM1, TMG7800-CTRL, TMG-CONTROL, TMG7800-TMS, Tsig, TSG800, TSG3200, TSG3200-RJ, TSG3200-TE, TSG3200-DS3, TSG3200-STM1, Ttrans, TMGIP800, TMGIP3200, TMGIP7800, Tmedia 1+1, Tmedia N+1, TMG800+1, TMG3200-TE+1, TMG3200-DS3+1, TMG3200-STM1+1, TMG7800-TE+1, TMG7800-DS3+1, TMG7800-STM1+1, Tdev, TMP800, TMP6400, TMP6400-CTRL, TMP6400-TMS, Tmonitor, TM1000, TM3000, Toopack, Toolpack API, TB640, TB-8, TB-16, and TB-Video, are trademarks of TelcoBridges Inc. All other trademarks are the property of their owners. This information is subject to change without notice.

Issue 5.0f

HEAD OFFICE

TelcoBridges Inc.
91 rue de la Barre, Suite 01
Boucherville, QC, J4B 2X6
CANADA
www.telcobridges.com

T +1 450 655 8993
F +1 450 655 9511
info@telcobridges.com

TB Support - Technical Support

Tel: +1 438 338 2100
support@telcobridges.com
www.telcobridges.com/en/tbsupport.aspx

Preface



About this Guide

This guide provides installation, and setup procedures for the 3200 series standalone and 3200 series 1+1 systems.

Conventions

Terminology	Description
3200 series gateway	This term is used when a description applies to both the 3200 series standalone system and 3200 series 1+1 system.
3200 series standalone system	This term is used when a description applies to the 3200 series unit operating as a standalone unit.
3200 series 1+1 system	This term is used when a description applies to the 3200 series unit operating in conjunction with the 3200 series +1. This term also includes the 1+1 patch panel(s).
3200 series unit	This term is used when a description applies to all variations of the 3200 series units, such as: TMG3200 (TMG3200-RJ, TMG3200-TE, TMG3200-DS3, or TMG3200-STM1), or TSG3200 (TSG3200-RJ, TSG3200-TE, TSG3200-DS3), or TMGIP3200.
3200-RJ	This term is used when a description applies to the TMG3200-RJ and TSG3200-RJ.
3200-TE	This term is used when a description applies to the TMG3200-TE and TSG3200-TE.
3200-DS3	This term is used when a description applies to the TMG3200-DS3 and TSG3200-DS3.
3200-STM1	This term is used when a description applies to the TMG3200-STM1 and TSG3200-STM1.
3200 series +1 unit	This term is used when a description applies to all variations of the 3200 series +1 units, such as: TMG3200 +1 (TMG3200-RJ, TMG3200-TE, TMG3200-DS3, or TMG3200-STM1), or TSG3200 +1 (TSG3200-RJ, TSG3200-TE, TSG3200-DS3), or TMGIP3200 +1.
1+1 Patch Panel	This term is used as a generic reference to 1+1 patch panel(s), which enables a 3200 series to connect to a 3200 series +1.

To help guide you through the installation of your gateway, the following icons are used. Take note of the icon that represents the type of installation you are conducting and follow it throughout this guide to ensure proper installation and gateway setup.

Graphics	Description
	<p>This icon appears in the margins of pages describing the 3200 series operating as a standalone unit. If you are installing a standalone unit read and follow the instructions provided in those sections and pages.</p>
	<p>This icon appears in the margins of pages describing the 3200 series operating in conjunction with a 3200 series +1 and 1+1 Patch Panel(s). If you are installing a 1+1 System read and follow the instructions provided in those sections and pages.</p>

Contact Us

If you have comments about this guide or any other TelcoBridges technical documentation, please send an email to marketing@telcobridges.com.

Table of Contents

Section 1	Introduction.....	1
1.1	Recognizing a 3200 Series Standalone versus a 3200 Series 1+1 System	2
1.1.1	3200 Series Standalone	2
1.1.2	3200 Series 1+1 System	2
1.1.3	Product Images	3
1.2	Installation Prerequisites	5
1.3	Preventing Electrostatic Discharge Damage.....	6
1.4	Recommended Reading.....	6
Section 2	Installing the Equipment	7
2.1	Package Contents	8
2.1.1	3200 Series Standalone Package Contents.....	8
2.1.2	3200 Series 1+1 System Package Contents.....	9
2.2	Rack Mounting the 3200 Series Standalone or 3200 Series 1+1 System	12
2.2.1	Prerequisites	12
2.2.2	Vertical Placement of the Equipment	12
2.2.3	Installing the 3200 Series Standalone and the 3200 Series 1+1 on an Equipment Rack ..	13
2.3	Choosing your Connection Procedures.....	15
2.4	3200 Series Standalone System	16
2.4.1	Connecting to the 3200 Series Gateway Management Interface.....	17
2.4.2	Connecting to a VoIP Network	18
2.4.3	Connecting to the PSTN.....	19
2.4.3.1	RJ48C Type Interface (T1/E1) for the 3200-RJ.....	20
2.4.3.2	SCSI Interface (T1/E1) for the 3200-TE	21
2.4.3.3	Dual BNC Interface (DS3) for the 3200-DS3.....	23
2.4.3.4	Optical Interface (OC3/STM-1) for the 3200-STM1.....	24
2.4.4	Powering Up.....	25
2.4.4.1	Connecting to AC Power	25
2.4.4.2	Connecting to DC Power.....	26
2.4.5	Start Up	27
2.4.5.1	Configuring the Role.....	27
2.5	3200 Series 1+1 System	29
2.5.1	Connecting to the 3200 Series 1+1 System Management Interfaces	30
2.5.2	Connecting to the Control Network	31
2.5.3	Connecting the 3200 Series 1+1 System VoIP Network(s).....	32
2.5.4	Connecting to the PSTN in a 3200 Series 1+1 System	33
2.5.4.1	RJ48C Type Interface (T1/E1) for the 3200-RJ and 3200-RJ+1	34
2.5.4.2	SCSI Interface (T1/E1) for the 3200-TE and 3200-TE+1	36
2.5.4.3	Dual BNC Interface (DS3) for the 3200-DS3 and 3200-DS3+1	38
2.5.4.4	Optical Interface (OC3/STM-1).....	39
2.5.5	Powering Up.....	41
2.5.5.1	Connecting to AC Power	41
2.5.5.2	Connecting to DC Power.....	42
2.5.6	Start Up	43
2.6	Adding a 3200 Series +1 Unit to an Existing Standalone, Creating a 3200 Series 1+1	

	System45	
2.6.1	Reconfigure a Standalone Unit as a Primary Unit in a 3200 Series 1+1 system	45
2.6.2	Install the 3200 Series +1 Unit on the Equipment Rack.....	47
2.6.3	Install a 1+1 Patch Panel	47
2.6.4	Connect to the 3200 Series 1+1 Management Interface.....	48
2.6.5	Connect to the 3200 Series 1+1 Control Network.....	48
2.6.6	Connect to the VoIP Network.....	48
2.6.7	Connect to the PSTN Network	49
2.6.8	Power Up the 3200 Series 1+1 System	50
2.6.9	Start Up	51
2.7	Verifying the LED Status Indications	52
2.8	Powering Down	54
Section 3	Initial System Configuration.....	55
3.1	Connecting to the Serial Port of the 3200 Series Gateway	56
3.2	Configuring the Terminal Emulator Application	57
3.3	Connecting to the 3200 Series Gateway.....	57
3.4	Retrieving 3200 Series Gateway Information.....	58
3.5	Changing the 3200 Series Gateway Management Port IP Address	58
3.6	Changing 3200 Series Gateway Management Port Passwords	58
3.7	Setting the Time Zone	58
3.8	Configuring the 3200 Series Gateway Using the Web Portal.....	59
3.9	Changing VoIP Interface Addresses	59
Section 4	System Backups.....	61
4.1	Creating a Database Backup	62
4.2	Downloading a Database Backup	62
4.3	Uploading a Database Backup.....	62
4.4	Restoring a Database Backup.....	62
Appendix A	Wiring Diagrams.....	63
A.1	RJ48C Wiring Diagram: Crossover and Straight Cables.....	64
A.2	RJ48 Console Wiring Diagram	64



Section 1 Introduction

This chapter provides an introduction to the installation and setup for the following configurations:



3200 Series Standalone: Single gateway unit operating in standalone mode.



3200 Series 1+1 System: 3200 series unit operating in conjunction with a 3200 series +1 unit, and 1+1 patch panel(s).

Note 1+1 Patch panels are only available for the TMG3200 and TSG3200.

The following topics are covered:

- Section 1.1 “Recognizing a 3200 Series Standalone versus a 3200 Series 1+1 System”
- Section 1.2 “Installation Prerequisites”
- Section 1.3 “Preventing Electrostatic Discharge Damage”
- Section 1.4 “Recommended Reading”



1.1 Recognizing a 3200 Series Standalone versus a 3200 Series 1+1 System



1.1.1 3200 Series Standalone

The 3200 series standalone consists of one telecom unit. The front and rear views are shown in figure 1.1 on page 3.

1.1.2 3200 Series 1+1 System

The 3200 series 1+1 system, see figure 1.1 on page 3 and figure 1.2 on page 4, consists of:

- One (1) telecom unit
- One (1) +1 telecom unit
- One (1) or two (2) 1+1 patch panels(s)

1.1.3 Product Images



TMG3200/TSG3200/TMGIP3200 (front view)

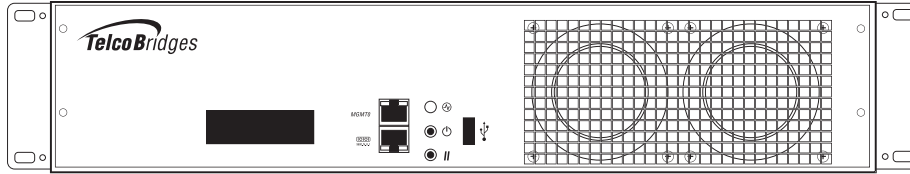

TMG3200-RJ/TMG3200-RJ+1 and TSG3200-RJ/TSG3200-RJ+1

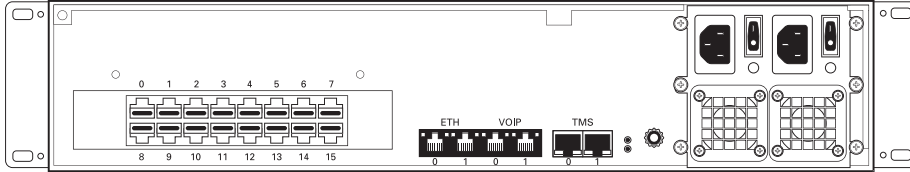

TMG3200-TE/TMG3200-TE+1 and TSG3200-TE/TSG3200-TE+1

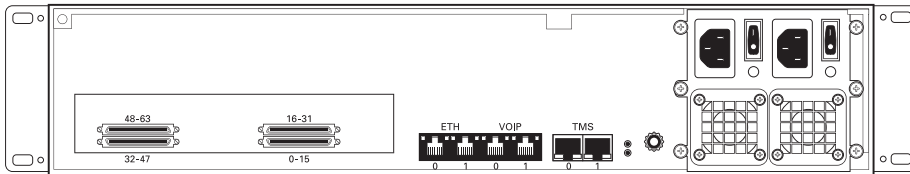

TMG3200-DS3/TMG3200-DS3+1 and TSG3200-DS3/TSG3200-DS3+1

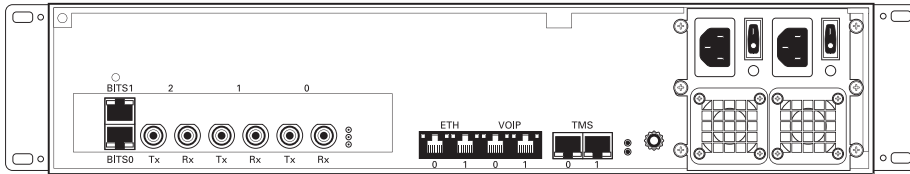

TMG3200-STM1/TMG3200-STM1+1 and TSG3200-STM1/TSG3200-STM1+1

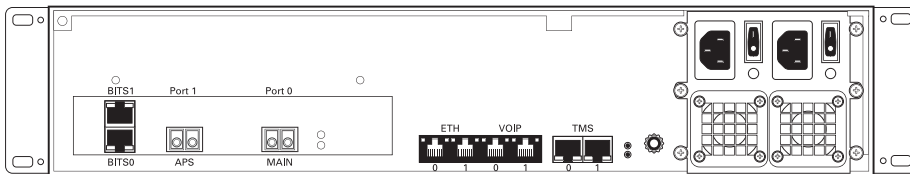

TMGIP3200

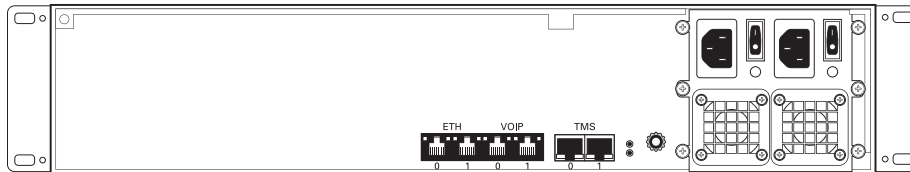

Figure 1.1 3200 Series and 3200 Series +1 Front and Rear Views

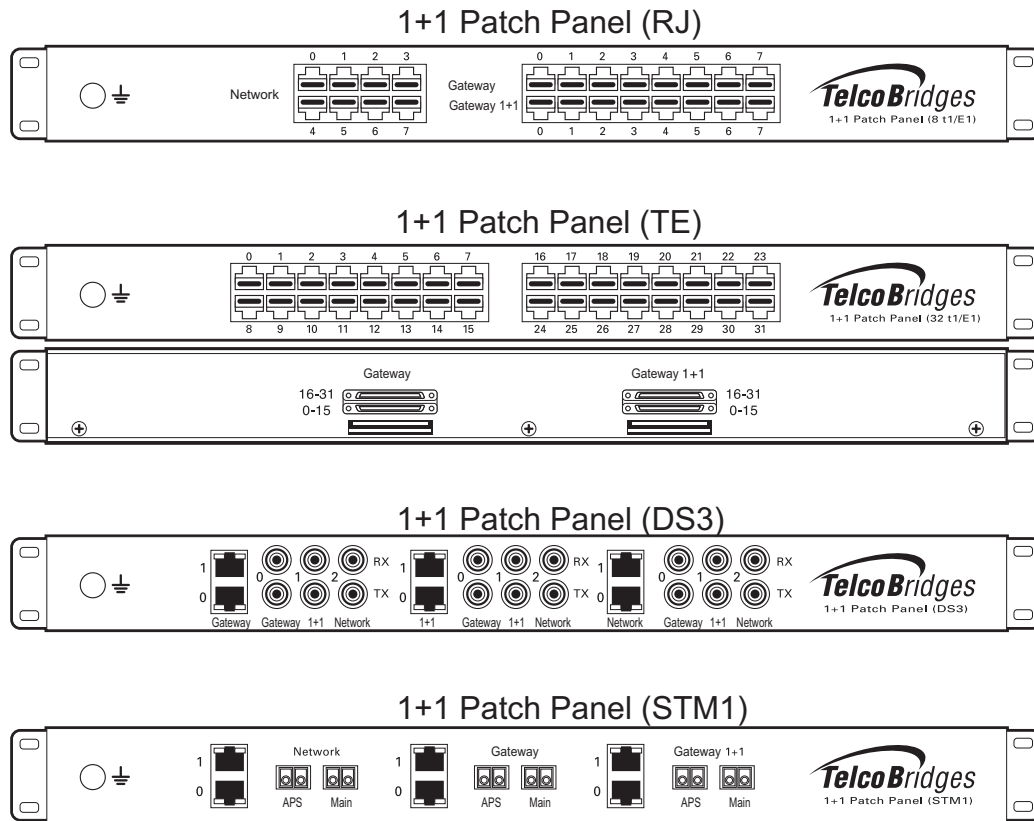



Figure 1.2 1+1 Patch Panels

1.2 Installation Prerequisites

For the installation to proceed without interruption, it is important that you verify that you have all necessary materials on hand.



 3200 Series Standalone	 3200 Series 1+1 System								
<p>Adequate space for the installation of the 3200 Series Standalone. You will need to mount the 3200 series unit on a 19" equipment rack (customer provided). Your 3200 series unit is a 2U unit.</p> <p>Adequate power supply and power connections. The 3200 series unit requires two power connections to provide for its redundant power supply.</p> <p>To guarantee an uninterrupted supply of electricity, each power connection must be fed by a dedicated power source.</p> <p>An IP address for the management port. To avoid delays, you should have the IP address, netmask and gateway addresses on hand. Take note that the management port supports DHCP, see Section 2.4.1 "Connecting to the 3200 Series Gateway Management Interface" on page 17 for further information.</p>	<p>Adequate space for the installation of your 3200 Series 1+1 system. You will need to mount the 3200 series 1+1 system on a 19" equipment rack (customer provided).</p> <p>Your 1+1 System requires space for the following number of units:</p> <table data-bbox="922 793 1312 926"> <tr> <td>3200 Series Unit:</td> <td>2U</td> </tr> <tr> <td>3200 Series +1 Unit:</td> <td>2U</td> </tr> <tr> <td>1+1 Patch Panel:</td> <td>1U or 2U^a</td> </tr> <tr> <td>Total:</td> <td>5U or 6U^b</td> </tr> </table> <p>Adequate power supply and power connections. The 3200 series and 3200 series +1 units require two power connections each, as they are equipped with redundant power supplies. To guarantee an uninterrupted supply, each power connection must be fed by a dedicated power source.</p> <p>An IP address for the management port. To avoid delays, you should have the IP address, netmask and gateway addresses on hand. Take note that the management port supports DHCP, see Section 2.5.1 "Connecting to the 3200 Series 1+1 System Management Interfaces" on page 30 for further information.</p>	3200 Series Unit:	2U	3200 Series +1 Unit:	2U	1+1 Patch Panel:	1U or 2U ^a	Total:	5U or 6U ^b
3200 Series Unit:	2U								
3200 Series +1 Unit:	2U								
1+1 Patch Panel:	1U or 2U ^a								
Total:	5U or 6U ^b								

a. 1U per 1+1 patch panel, 2U if two patch panels are required

b. Depending on whether your system required 1 or 2 patch panels. Refer to Section 2.1.2 "3200 Series 1+1 System Package Contents"



1.3

Preventing Electrostatic Discharge Damage

Electrostatic discharge (ESD) can damage equipment and impair electrical circuitry. It may occur if electronic printed circuit cards are improperly handled and may cause complete or intermittent failure.



Warning

Always follow ESD prevention procedures when removing and replacing modules:

- Ensure that the gateways are grounded.
- Wear an ESD-preventive wrist strap and ensure that it makes good contact with your skin. Connect the wrist strap clip to an unpainted surface of the equipment or the grounded equipment rack in order to channel away all ESD voltage safely to ground. To guard against ESD damage and shocks, the wrist strap and cord must be in proper working condition.
- If no wrist strap is available, and you must work with the equipment, ground yourself by touching a metal part of the chassis.

1.4

Recommended Reading

This document assumes that you have a clear understanding of the installation of the equipment described in this document and have been trained to work with the equipment. If you have any technical questions, TelcoBridges TB Support (technical support team) can be reached at the following numbers or an email can be sent to: support@telcobridges.com.

- Americas & Europe Technical Support Centre (GMT-05:00, Montreal):
Telephone: +1-450-655-8993 x131 or x102
- Asia Technical Support Centre (GMT +08:00, Hong Kong)
Telephone: +852-3749-9818
- 24/7 International Support
Telephone: +1-866-438-4703

Documents exploring various aspects of the product are available on the TB Wiki:
<http://docs.telcobridges.com>



Section 2 Installing the Equipment

This chapter provides information about the following topics:

- Section 2.1 “Package Contents”
- Section 2.2 “Rack Mounting the 3200 Series Standalone or 3200 Series 1+1 System”
- Section 2.3 “Choosing your Connection Procedures”
- Section 2.4 “3200 Series Standalone System”
- Section 2.5 “3200 Series 1+1 System”
- Section 2.6 “Adding a 3200 Series +1 Unit to an Existing Standalone, Creating a 3200 Series 1+1 System”
- Section 2.7 “Verifying the LED Status Indications”
- Section 2.8 “Powering Down”



2.1 Package Contents

Depending on your system requirements, you may receive one or more of the following items:

- Section 2.1.1 “3200 Series Standalone Package Contents” on page 8.
- Section 2.1.2 “3200 Series 1+1 System Package Contents” on page 9.
- Section “1+1 Patch Panels” on page 11.

The contents of these devices are described in the following sections.

2.1.1 3200 Series Standalone Package Contents

TMG3200, TSG3200, TMGIP3200

In the box, you will find the following items:

- One 3200 series unit:
TMG3200 (TMG3200-RJ, TMG3200-TE, TMG3200-DS3, or TMG3200-STM1), or TSG3200 (TSG3200-RJ, TSG3200-TE, TSG3200-DS3), or TMGIP3200. See figure 1.1 on page 3.
- One set of mounting brackets and screws, used to mount the 3200 series unit to a 19" rack.
- One DB-9 to RJ-45 adapter to interface the serial port of your computer with the RJ-45 port of the 3200 series unit.
- Three CAT5 Ethernet (blue) straight cables (male-male), 3 meters in length.
- One Important Notice (two-sided document containing pertinent product serial numbers, and other important information).
- One Product Warranty.
- One packing slip.
- One Quick Installation Guide (two-sided document that provides a pictorial view of the equipment setup).
- Two AC or DC power cables

Specifically with the 3200-TE unit, you will also have:

- One or two patch panel(s)
- Two SCSI cables per patch panel.

Not included

- A 19" equipment rack. The 3200 series unit must be installed on a 19" wide equipment rack.

2.1.2 3200 Series 1+1 System Package Contents

TMG3200, TSG3200, TMGIP3200

In the box, you will find the following items:



- One 3200 series unit:
TMG3200 (TMG3200-RJ, TMG3200-TE, TMG3200-DS3, or TMG3200-STM1), or TSG3200 (TSG3200-RJ, TSG3200-TE, TSG3200-DS3), or TMGIP3200. See figure 1.1 on page 3.
- One set of mounting brackets and screws, used to mount the 3200 series unit to a 19" rack.
- One DB-9 to RJ-45 adapter to interface the serial port of your computer with the RJ-45 port of the 3200 series unit.
- Three CAT5 Ethernet (blue) straight cables (male-male), 3 meters in length.
- One Important Notice (two-sided document containing pertinent product serial numbers, and other important information).
- One Product Warranty.
- One packing slip.
- One Quick Installation Guide (two-sided document that provides a pictorial view of the equipment setup).
- Two AC or DC power cables

Specifically with the TMG3200-TE and TSG3200-TE, you will also have:

- One or two (2) patch panel(s)
- Two SCSI cables per patch panel.

Not included

- A 19" equipment rack. The 3200 series unit must be installed on a 19" wide equipment rack.

TMG3200 +1, TSG3200 +1, TMGIP3200 +1

In the box, you will find the following items:

- One 3200 +1 series unit:
TMG3200 +1 (TMG3200-RJ, TMG3200-TE, TMG3200-DS3, or TMG3200-STM1), or TSG3200 +1 (TSG3200-RJ, TSG3200-TE, TSG3200-DS3), or TMGIP3200 +1. See figure 1.1 on page 3.
- One set of mounting brackets and screws, used to mount the 3200 +1 series unit to a 19" rack.
- One DB-9 to RJ-45 adapter to interface the serial port of your computer with the RJ-45 port of the 3200 + 1 series unit.
- Three CAT5 Ethernet (blue) straight cables (male-male), 3 meters in length.
- One Important Notice (two-sided document containing pertinent product serial numbers, and other important information).



- One Product Warranty.
- One packing slip.
- One Quick Installation Guide (two-sided document that provides a pictorial view of the equipment setup).
- Two AC or DC power cables

Specifically with the TMG3200-TE+1 and TSG3200-TE+1, you will also have:

- One or two patch panel(s)
- Two SCSI cables per patch panel.

Not included

- A 19" equipment rack. The 3200 +1 series unit must be installed on a 19" wide equipment rack.

1+1 Patch Panels

1+1 patch panels are required for the proper connection of the 3200 series 1+1 system, and are automatically included when a 3200 +1 series unit is ordered. Table 2.1 lists the various 1+1 patch panels that you will receive based upon the type of 3200 series telecom unit integrated in your 3200 series 1+1 system.



Table 2.1 1+1 Patch Panels

<p>1+1 Patch Panel (8/T1/E1)</p>	<p>Provides connection for up to 8 T1/E1 lines from the network to the 1+1 Patch Panel (8 T1/E1) and then links to the 3200-RJ and 3200-RJ+1</p> <p>To connect the 3200-RJ-8 to its +1 unit you require one 1+1 Patch Panel (8 T1/E1).</p> <p>To connect the 3200-RJ-9 and greater capacity (up to the 3200-RJ-16) to its respective +1 unit, you require two 1+1 Patch Panels (8 T1/E1).</p> <p>Cables provided:</p> <p>You will be provided with 16 RJ48C cables (yellow), two meters in length, per 1+1 Patch Panel (8 T1/E1) you receive.</p>
<p>1+1 Patch Panel (32/T1/E1)</p>	<p>Provides connection for up to 32 T1/E1 lines from the network to the 3200-TE and 3200-TE+1.</p> <p>To connect the 3200-TE-16 and the 3200-TE-32 to their respective +1 units and the network, you will required one 1+1 Patch Panel (32 T1/E1).</p> <p>To connect the 3200-TE-48 and the 3200-TE-64 to their respective +1 units and the network, you will require two 1+1 Patch Panel (32 T1/E1).</p> <p>Cables provided:</p> <p>4 SCSI straight cables per 1+1 Patch Panel (32 T1/E1). Three meters in length. This provides connection for up to 32 lines.</p>
<p>1+1 Patch Panel (DS3)</p>	<p>Provides connection for up to 3 DS3 lines from the network to the 3200-DS3 and 3200-DS3+1.</p> <p>Cables provided (with each 1+1 Patch Panel (DS3)):</p> <ul style="list-style-type: none"> • 12 DS3 cables, each two meters in length. • 4 RJ48C straight cables (yellow), two meters in length.
<p>1+1 Patch Panel (STM1)</p>	<p>Provides connection of 1 STM1 line from the network to the 3200-STM1 and 3200-STM1+1.</p> <p>Cables provided (with each 1+1 Patch Panel (STM1)):</p> <ul style="list-style-type: none"> • 4 pairs of fiber optic cables, two meters in length. • 4 RJ48C straight cables (yellow), two meters in length.



2.2 Rack Mounting the 3200 Series Standalone or 3200 Series 1+1 System



The 3200 series equipment is mounted on a customer provided equipment rack using the mounting hardware packaged in the box.

2.2.1 Prerequisites

To rack mount the equipment, you will need:

- One 19" customer-provided equipment rack. The rack must be solidly anchored to the floor with appropriate support at the top of the racks.
- Climate controlled room: 0 to +50 Celsius, 0 to 95% non-condensing humidity.

2.2.2 Vertical Placement of the Equipment

The 3200 series standalone and 3200 series +1 are each housed in a 2U chassis, as tabulated in table 2.2 on page 12. It is important that you provide for enough room on the equipment rack to allow for the installation of the equipment.

Consider the available space on your equipment rack and the height of the 3200 series gateway equipment. Due to the rear-exhaust heat vents and the efficient heat dissipation design, there is no need to leave any physical vertical space above or below the 3200 series gateway equipment on the rack.

Table 2.2 3200 Series Gateway Physical Height

3200 Series	Vertical Height
3200 series standalone	2U (3.5 inches or 89.10 mm)
3200 +1 series	2U (3.5 inches or 89.10 mm)
Patch Panels	1U (1.75 inches or 44.45 mm)

2.2.3 Installing the 3200 Series Standalone and the 3200 Series 1+1 on an Equipment Rack

Both the 3200 series standalone and the 3200 series 1+1 system are mounted on the 19" equipment rack using the angle brackets and screws provided in the box.



Mounting the 3200 Series Standalone:

1. Using four metal screws, attach one angle bracket to the front, left-hand side of the 3200 series unit, when viewed from the front, as shown in figure 2.1 on page 14. Do the same for the angle bracket on the right-hand side.
2. Start mounting equipment at the top-most position of the rack, keeping in mind the space required on the equipment rack as described in Section 2.2.2 "Vertical Placement of the Equipment" on page 12.



Mounting the 3200 Series 1+1 System:

1. Mount the 3200 series unit as mentioned above:
2. Install the 3200 series +1 unit below the TMG3200, as shown in figure 2.1 on page 14.
3. To attach the 3200 series +1 unit to the equipment rack, follow the previous procedure.
4. Install the patch panel below the 3200 series +1 unit, as shown in figure 2.1 on page 14.

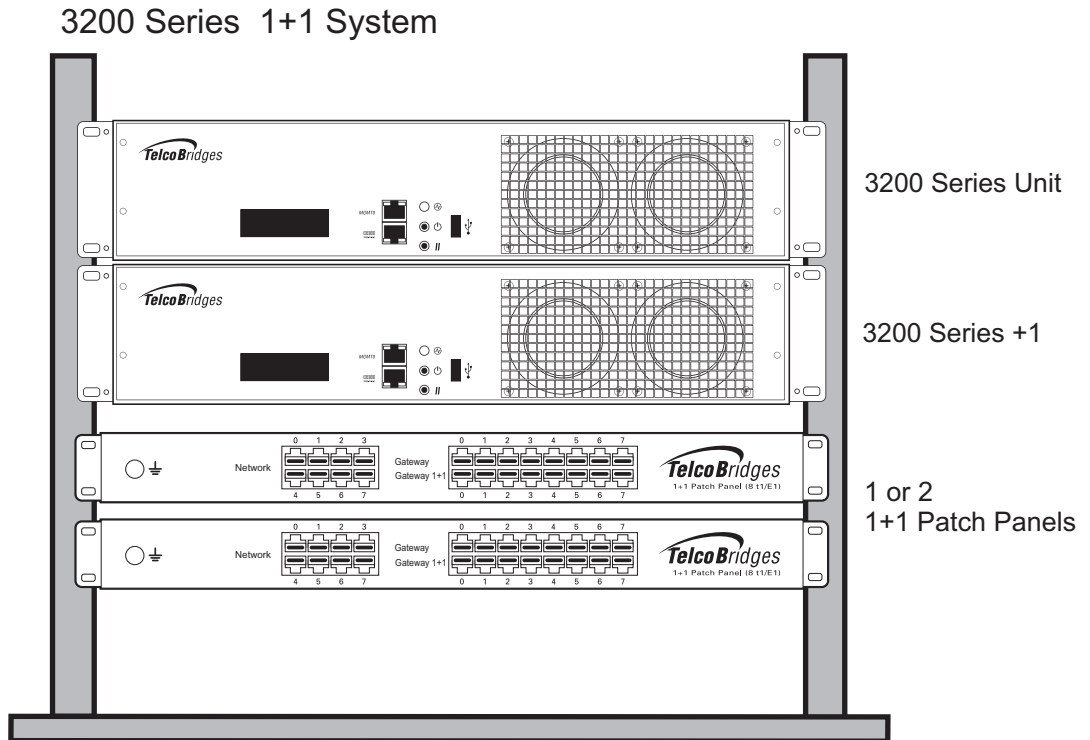
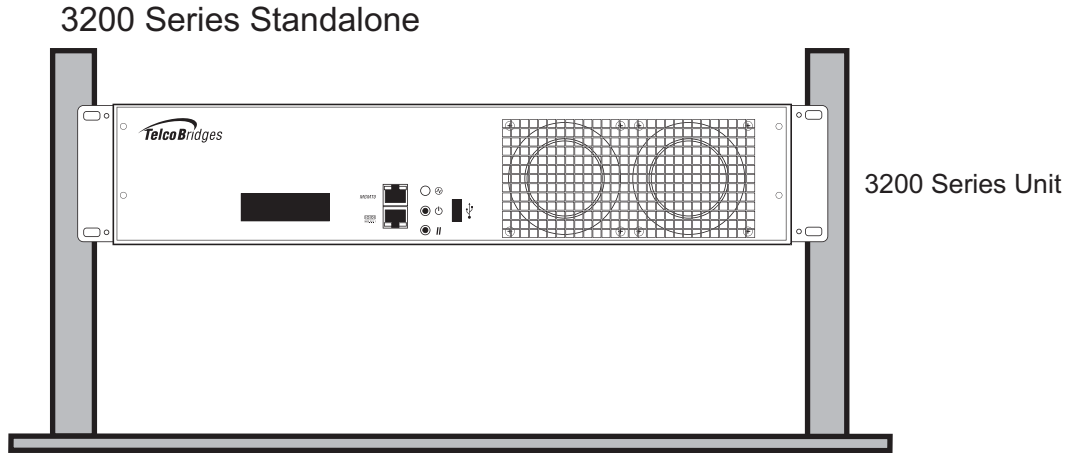
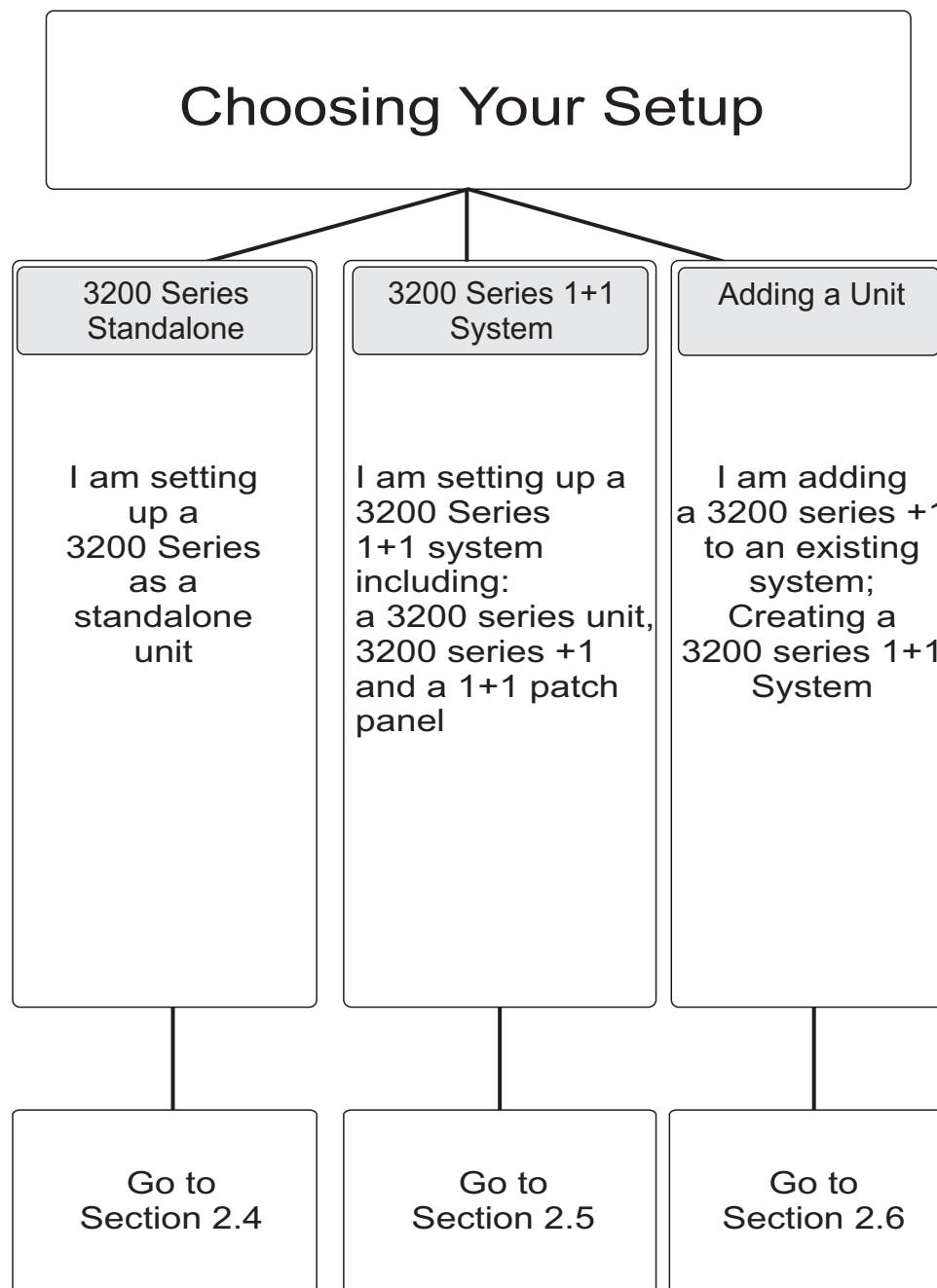

Figure 2.1 Rackmounting the Equipment

2.3 Choosing your Connection Procedures

Use the following diagram to guide you to the appropriate section, based on your chosen installation.





2.4

3200 Series Standalone System

If you are here, you have a 3200 series unit that you will setup as a standalone system. This section covers the following procedures for a 3200 series standalone system:

- Section 2.4.1 “Connecting to the 3200 Series Gateway Management Interface”.
- Section 2.4.2 “Connecting to a VoIP Network”.
- Section 2.4.3 “Connecting to the PSTN”.
- Section 2.4.4 “Powering Up”.
- Section 2.4.5 “Start Up”.

2.4.1 Connecting to the 3200 Series Gateway Management Interface



The 3200 series gateway management interface enables administrators to perform management tasks on the 3200 series unit.

Prerequisites

To communicate with the management interface, the following is needed:

- One CAT5 Ethernet cable with RJ45 male-male terminations.

Interconnections

The 3200 series gateway provides a management interface, using one gigabit ethernet network link, as shown in figure 2.2 on page 17.

To communicate with the management interface:

1. Connect the supplied CAT5 Ethernet cable to the port labelled “MGMT0” at the front of the 3200 series gateway.

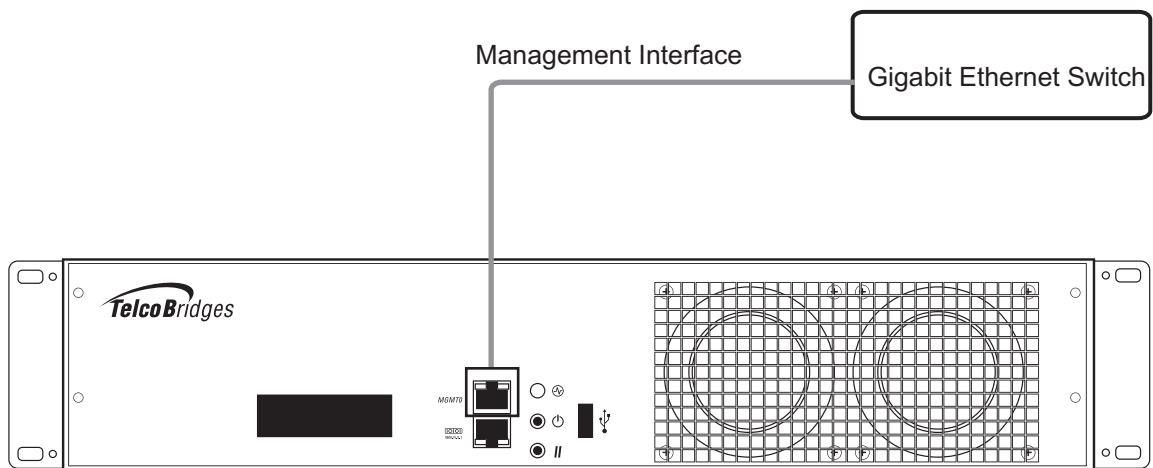

Figure 2.2 Management Interface



2.4.2 Connecting to a VoIP Network

The 3200 series gateway features dual GigE ports for connection to different VoIP networks. This provides an access point to manage VoIP traffic. Should one of the IP networks fail, the 3200 series gateway will continue to manage VoIP traffic using the alternate network.

The IP address of the VoIP ports can be modified using the web portal.

Note: Certain configurations of the 3200 series gateway will exceed 100 Mbps, therefore 1000 Mbps is recommended.

Prerequisites

To connect the 3200 series gateway to the VoIP network, you will need:

- Gigabit layer 2 Ethernet switch. A second one is required to support redundancy of the VoIP interface.
- One or two CAT5 Ethernet cables with RJ45 male-male terminations.
- If your system has access to a second VoIP network, you can connect it to a second VoIP interface of the 3200 series gateway with an RJ45 (male-male) CAT5 Ethernet cable.

Connections

The 3200 series gateway is connected to the VoIP network by one or optionally two Ethernet GigE network links, as shown in figure 2.3 on page 18.

To connect to the VoIP network:

1. Connect a CAT5 Ethernet cable to VoIP0 at the rear of the 3200 series gateway. Connect the other end of the same CAT5 cable to the Gigabit Ethernet switch.
2. If your system employs a second Gigabit Ethernet switch for redundancy, connect a second CAT5 Ethernet cable to VoIP1 at the rear of the 3200 series gateway. Connect the other end of the same CAT5 cable to the second Gigabit Ethernet switch.

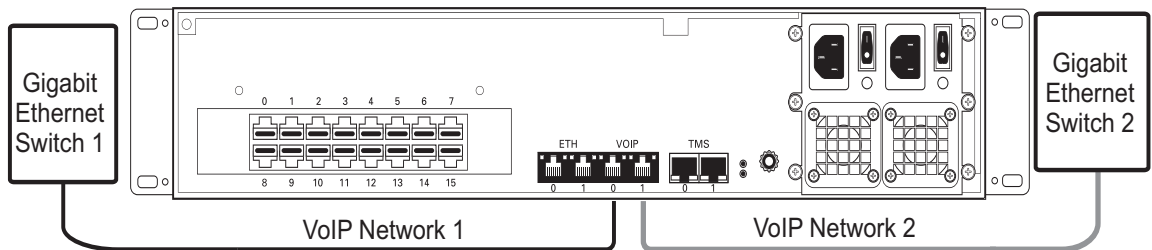

Figure 2.3 Connecting to the VoIP Network

2.4.3 Connecting to the PSTN

The 3200 series gateway features a variety of interfaces to the PSTN network.



Note This section only applies to the TMG3200 and TSG3200 systems.

Prerequisites

To connect to the PSTN network, you must comply with one of the following:

- Your 3200-RJ features 16 modular 8-conductor RJ48C type jacks for connection to T1/E1 lines. You will need one cable for each (T1/E1) interface. If you are making your own cables, refer to page 63 in Appendix A in for crossover or straight cable wiring connections.
- Your 3200-TE features SCSI connectors for connection to T1/E1 lines. You will require one patch panel for each 32-line grouping of T1/E1 line interfaces.
- Your 3200-DS3 features BNC connectors for connection to DS3 lines. You will require two coaxial cables for each DS3 interface.
- Your 3200-STM1 features electrical or optical STM-1 connectors. You will require two fibre optic cables for each STM-1 interface.



2.4.3.1

RJ48C Type Interface (T1/E1) for the 3200-RJ

A 3200-RJ with 16 RJ48C type ports enables the connection to T1/E1 lines. The termination impedance is set at 100 ohms for T1 lines and 120 ohms for E1 lines. It is possible to connect an external balun in order to convert the line impedance to 75 ohms.

If you are making your own cables, refer to Section A.1 “RJ48C Wiring Diagram: Crossover and Straight Cables” on page 64 for crossover or straight cable wiring connections.

Note All ports may not be active. T1/E1 ports are activated by software license; the number of active ports depends on the licenses purchased.

To connect the 3200-RJ (RJ48C type) to the PSTN:

1. Start with port 0 located at the top and leftmost position. Connect one cable between this port and the T1/E1 line. See figure 2.4 on page 20.
2. Repeat step 1, using the next available port.

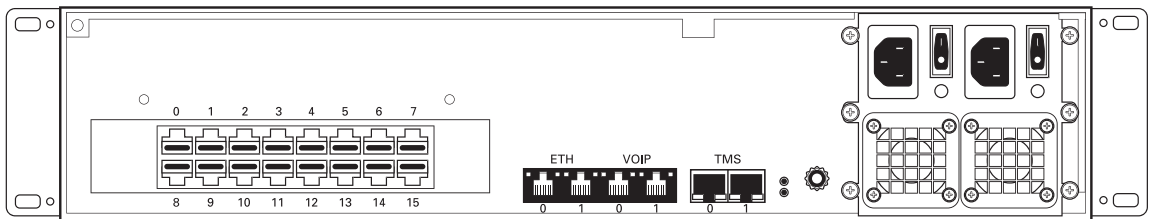

Figure 2.4 3200-RJ 16-Port Interface to the PSTN

2.4.3.2 SCSI Interface (T1/E1) for the 3200-TE

A 3200-TE with 4 SCSI connectors enables the connection to T1/E1 lines. The termination impedance is set at 120 ohms. It is possible to connect an external balun in order to convert to 75 ohms.



Note All ports may not be active. T1/E1 ports are activated by software license; the number of active ports depends on the licenses purchased.

Patch panels use straight connections. In other words, they do not cross the RX and TX signals. Connections between the patch panels and the 3200 series gateway require straight cables. The supplied SCSI cables are straight cables. Cables used to connect the network to the patch panel must do the cross connection.

To connect the 3200-TE to the PSTN:

1. Start with SCSI ports 0-15 located at the bottom right as shown in figure 2.5 on page 22. Connect one SCSI cable between this port and SCSI patch panel number 1, ports 0-15. Connect SCSI ports 16-31 to patch panel number 1, ports 16-31.
2. Repeat step 1, using lines 32-63 and a second patch panel. Connect lines 32-47 to patch panel 2, ports 0-15. Connect lines 48-63 to patch panel 2, ports 16-31.

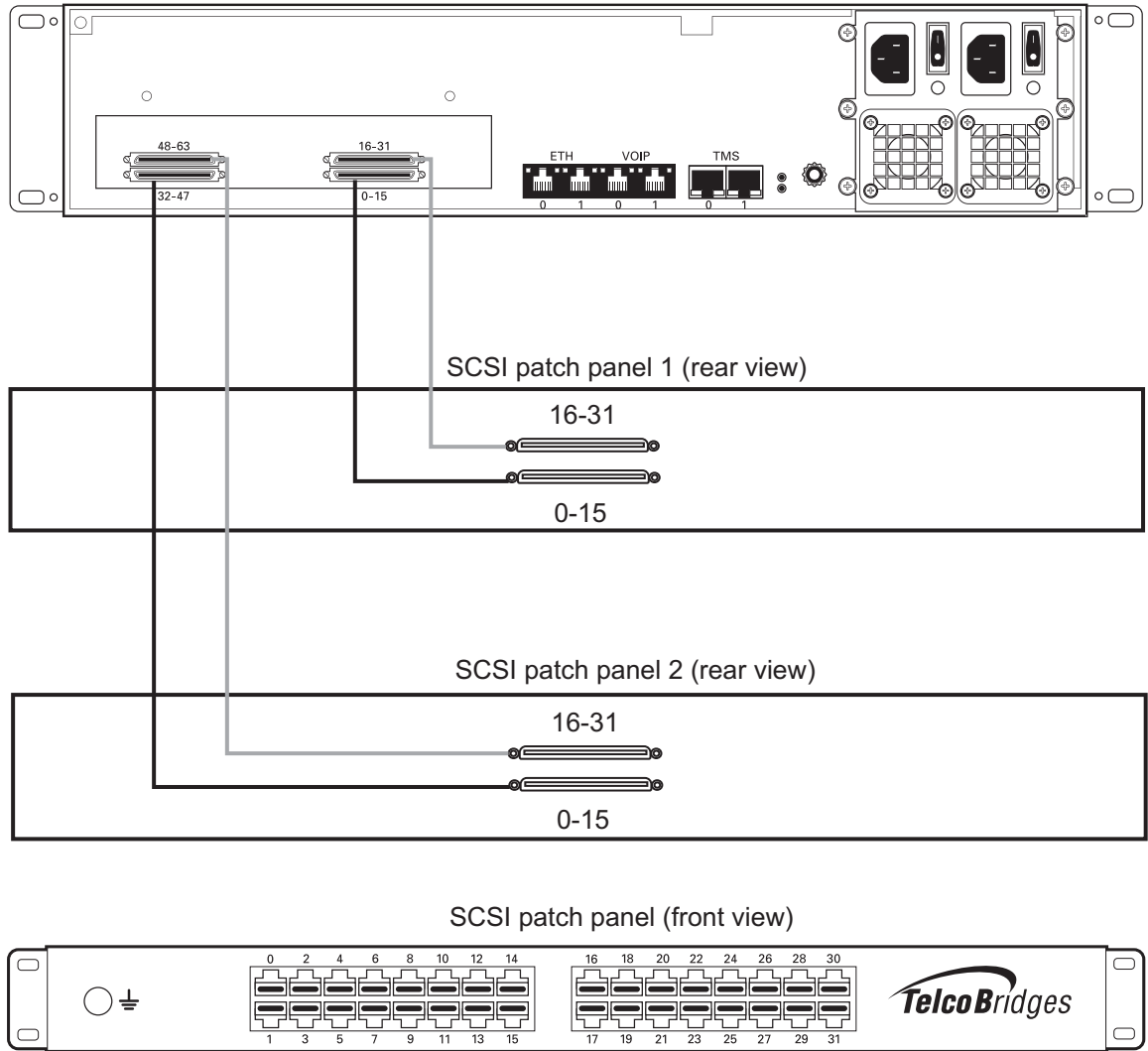

Figure 2.5 3200-TE with SCSI connectors

2.4.3.3 Dual BNC Interface (DS3) for the 3200-DS3

A 3200-DS3 with 3 sets of BNC connectors enables the connection to DS3 lines. See figure 2.6 on page 23.



Note All ports may not be active. DS3 ports are activated by software license; the number of active ports depends on the licenses purchased.

To connect the 3200-DS3 to the PSTN:

1. Start with the Dual BNC port pair #0 (right-most) as shown in figure 2.6 on page 23. Connect one pair of BNC cables between this port and the DS3 line.
2. Repeat step 1, using the next available pair of BNC PSTN interface ports.

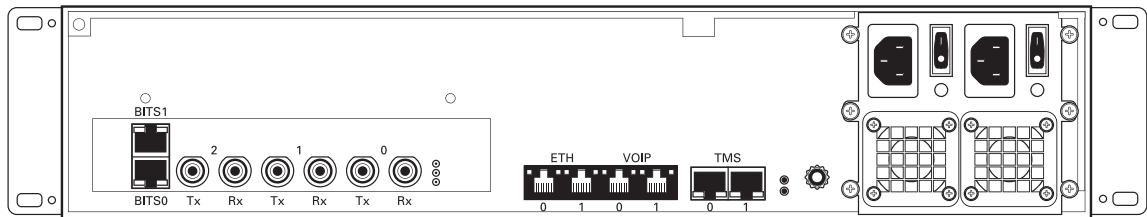

Figure 2.6 3200-DS3 Interface to the PSTN



2.4.3.4 Optical Interface (OC3/STM-1) for the 3200-STM1

A 3200-STM-1, with one main and one backup OC3 or STM1 port enables connection to OC3/STM1 lines. See figure 2.7 on page 24. Refer to table 2.3 on page 24 for a listing of optical interfaces. The default SFP module for OC3/STM1 connection is SMF, intermediate reach, (SFP-OC3-IR1) 1310 nm with LC type connectors.

Note Please make certain that the correct SFP model is selected at the time of ordering. If your installation requires a different model from the one that has been provided, you must replace it.

Table 2.3 Optical Interfaces

Transceiver Model	Description	Spec	Mode	Type	Range (Km.)	Wavelength (NM)	Connection
SFP-OC3-IR1	OC3/STM1	Hot Pluggable	Single-mode	Intermediate reach	15	1310	LC
SFP-STM1E	STM1E (Electrical)	Hot Pluggable	75 ohms Cooper	Max 180m	1	NA	DIN (mini-coax)

Automatic Protection Switching

The APS port is used for OC3/STM1 redundancy. Switchover occurs automatically based on configurable parameters. It is recommended that APS be used if the installation provides this feature.

To connect the 3200-STM1 (Optical Interface) to the PSTN:

1. Connect a fiber optic cable between the Port 0 (Main) port and OC3/STM1 line, as shown in figure 2.7 on page 24.
2. Connect a fiber optic cable between the Port 1 (APS) port and OC3/STM1 line.

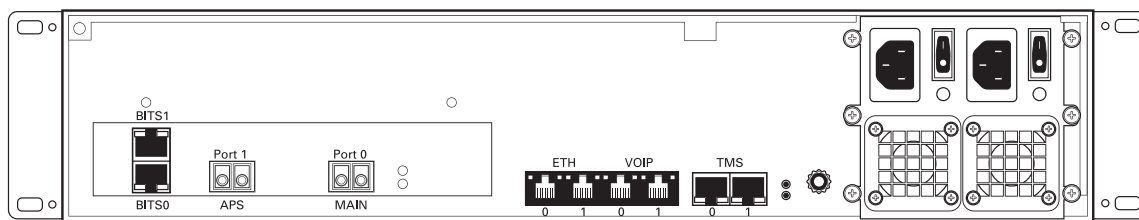

Figure 2.7 3200-STM1 Optical Interface to the PSTN



2.4.4 Powering Up

The 3200 series gateway is furnished with two AC or DC power connections. Only once all other equipment installation work has been completed should the 3200 series gateway be powered up.

2.4.4.1 Connecting to AC Power

Prerequisites

To power the 3200 series gateway, you will need:

- One to two power sources.
- Two power cables for the 3200 series gateway.

The 3200 series gateway AC model is furnished with two AC power connectors.

To connect to AC Power:

1. Connect an AC power cable between the AC connector of the TMG3200 and an AC supply. See figure 2.8 on page 25.

Note If the 3200 series gateway features a second power supply and it is not connected to an AC power source, press the green button located at the rear of the unit to disable the audible alarm. See figure 2.8 on page 25.

2. Power up the 3200 series gateway by turning on its power switch(es).

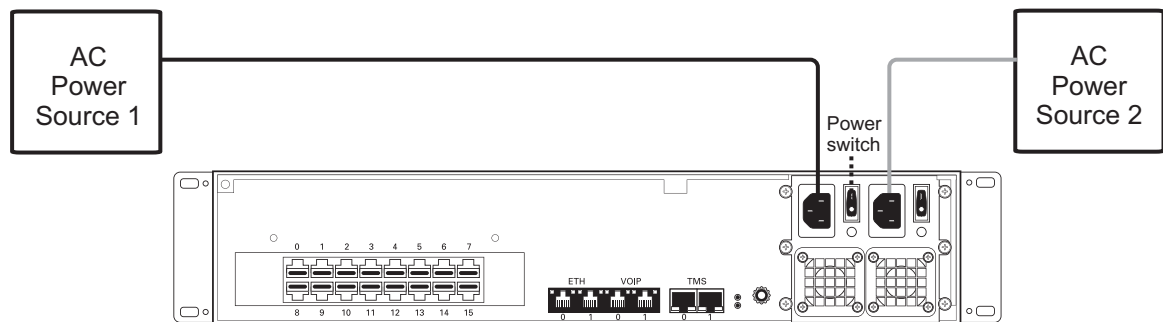

Figure 2.8 3200 Series Gateway AC Power Connection



2.4.4.2

Connecting to DC Power

The 3200 series gateway DC model is furnished with two DC power connection ports. In addition, each DC powered unit is supplied with two DC power cables.

To connect o DC power:

1. Connect one DC cable, supplied with the 3200 series gateway, as shown in figure 2.9 on page 26, to the rear of the unit.

Note Two types of cable with different coloring are available. Refer to figure 2.9 on page 26 for the appropriate wiring information.

2. Connect one lead of the DC power cable to the positive terminal of the DC power source.
3. Connect the other lead of the DC power cable to the negative side of the DC power source.
4. Repeat steps 1-3 for the second power DC power source.

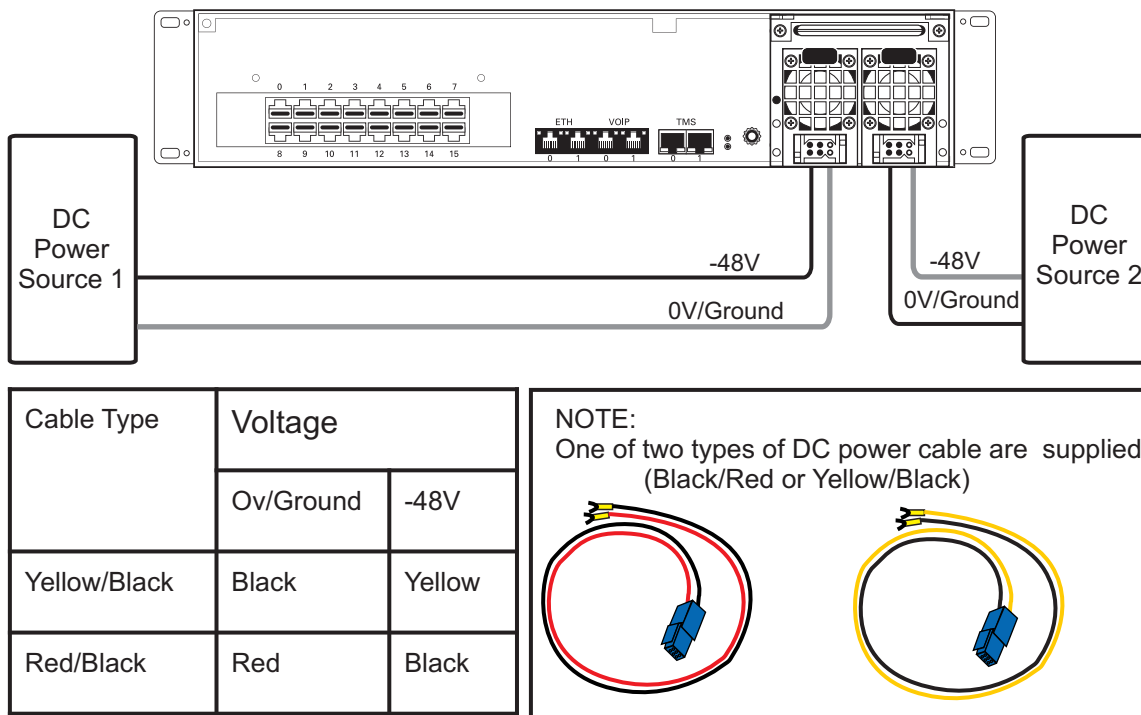

Figure 2.9 3200 Series Gateway DC Wiring Diagram

2.4.5 Start Up



The first time that you connect to a 3200 series gateway, the web portal will appear and you will be asked to select how you would like to configure the 3200 series gateway. You will want to be sure to set the role as a 3200 series standalone.

Once the configuration settings have been applied, the 3200 series gateway will start up and display the web portal configuration management tool.

2.4.5.1 Configuring the Role

To configure the role of the 3200 series gateway as a standalone unit, do the following:

1. Connect to the web portal of the standalone unit. The Welcome page appears.

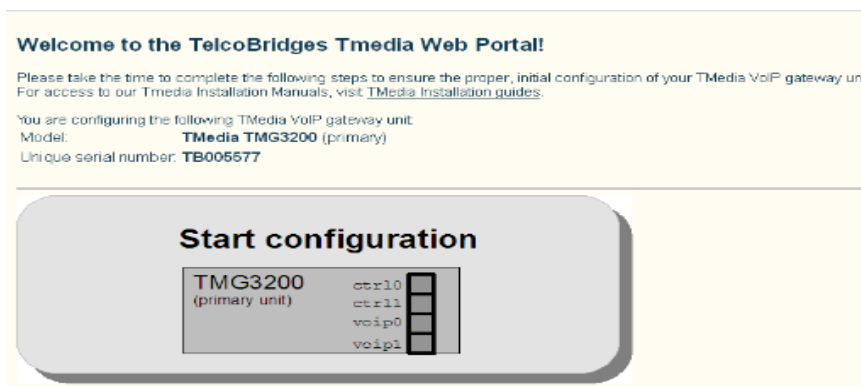

2. Click the 3200 series gateway image to set the role to a standalone gateway.

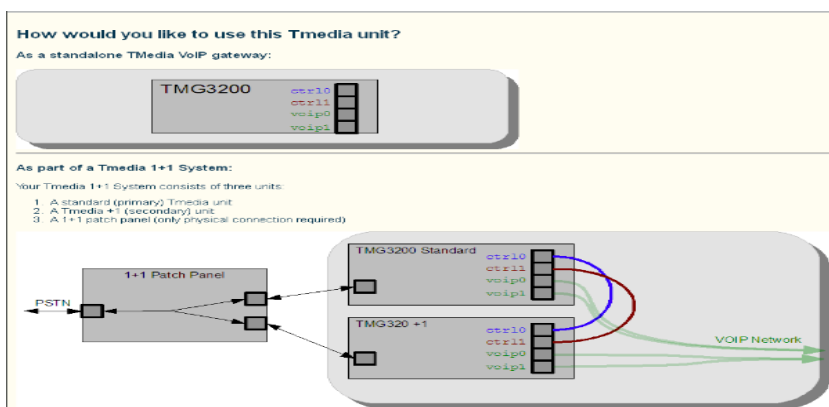



The Progress page is displayed, confirming the change.

Configuration is now in progress...



Configuration may take several minutes (up to ~3 minutes)
It may be impossible to refresh this web page at some point during that period.

If after the elapsed time you do not see any progress, please cancel the configuration to start again.

Cancel configuration

2.5 3200 Series 1+1 System

If you are here, you are installing a 3200 series 1+1 system. This section covers the following procedures:

- Section 2.5.1 “Connecting to the 3200 Series 1+1 System Management Interfaces” on page 30.
- Section 2.5.2 “Connecting to the Control Network” on page 31.
- Section 2.5.3 “Connecting the 3200 Series 1+1 System VoIP Network(s)” on page 32.
- Section 2.5.4 “Connecting to the PSTN in a 3200 Series 1+1 System” on page 33.
- Section 2.5.5 “Powering Up” on page 41.
- Section 2.5.6 “Start Up” on page 43.



2.5.1 Connecting to the 3200 Series 1+1 System Management Interfaces



The management interface enables administrators to perform management tasks on a 3200 series 1+1 system.

Prerequisites

To communicate with the management interface, the following is needed:

- Two CAT5 Ethernet cables with RJ45 male-male terminations.

Interconnections

A 3200 series 1+1 system provides a management interface for a 3200 series and a 3200 +1 gateway, each require a Gigabit Ethernet network link. See figure 2.10 on page 30.

To communicate with the management interface:

1. Connect an RJ45 cable from the 3200 series gateway to a gigabit ethernet switch.
2. Connect an RJ45 cable from the 3200 series +1 gateway to a gigabit ethernet switch.

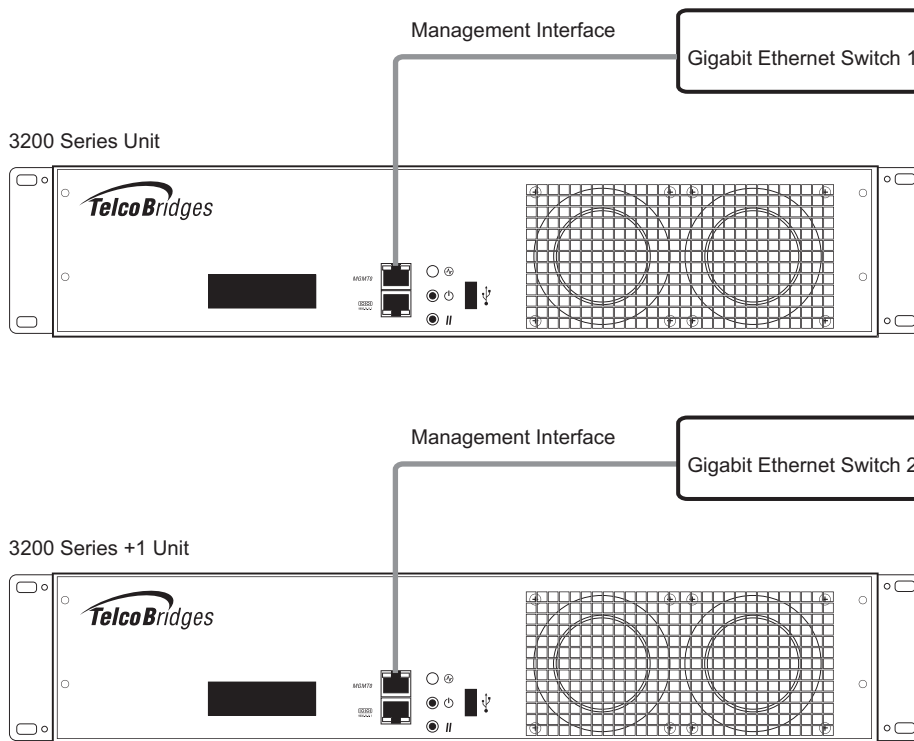

Figure 2.10 3200 Series 1+1 System Management Interface

2.5.2 Connecting to the Control Network

The 3200 series control network enables a 3200 series unit to be connected to a 3200 series +1 unit, allowing for a sharing of system resources.



Prerequisites

To connect to the control network, you will need:

- Two CAT5 Ethernet cables with RJ45 male-male terminations.

Connections

The 3200 series unit and 3200 series +1 are connected to the control network using two CAT5 Ethernet cables, as shown in figure 2.11 on page 31.

To connect to the control network:

1. Connect the ETH0 connector on the 3200 series unit to the ETH0 connector on the 3200 series +1 unit.
2. Connect the ETH1 connector on the 3200 series unit to the ETH1 connector on the 3200 series +1 unit.

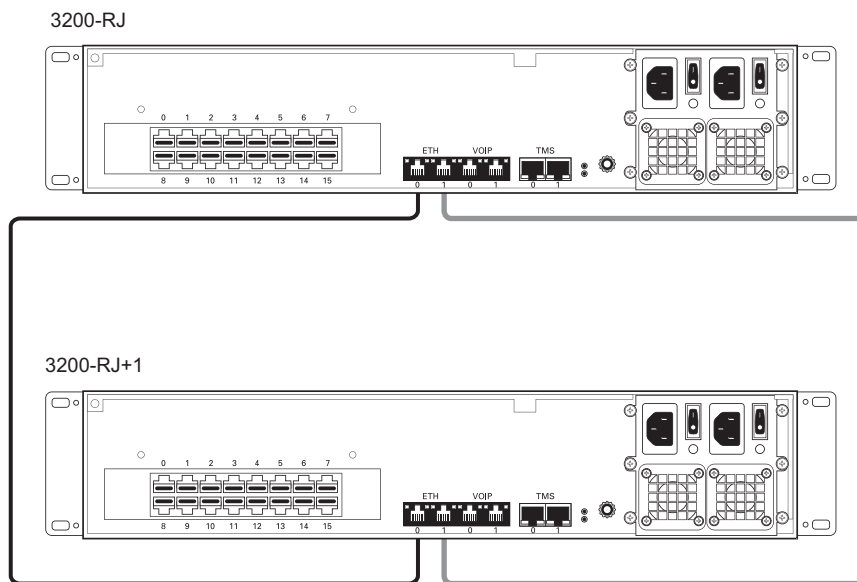

Figure 2.11 Connecting to the Control Network

2.5.3 Connecting the 3200 Series 1+1 System VoIP Network(s)



Each 3200 series unit and 3200 series +1 unit features dual GigE ports for connection to different VoIP networks. This provides an access point to manage VoIP traffic. Should one of the IP networks fail, the 3200 series 1+1 system will continue to manage VoIP traffic using the alternate network.

The IP address of the VoIP ports can be modified using the web portal.

Note: The 3200 series 1+1 system requires two (2) gigabit layer 2 Ethernet switches.

Prerequisites

To connect the 3200 series unit and 3200 series +1 unit to the VoIP network, you will need:

- Two gigabit layer 2 Ethernet switches. A second one is required to support redundancy of the VoIP interface.
- Four CAT5 Ethernet cables with RJ45 male-male terminations.
- Two IP addresses located on different subnets.

Connections

The 3200 series unit and 3200 series +1 unit are connected to the VoIP network by one or optionally two Ethernet GigE network links, as shown in figure 2.12 on page 32.

To connect to the VoIP network:

1. Connect the VoIP0 connector from both the 3200 series unit and 3200 series +1 unit to the first Ethernet switch.
2. Connect the VoIP1 connector from both the 3200 series unit and 3200 series +1 unit to the second Ethernet switch.

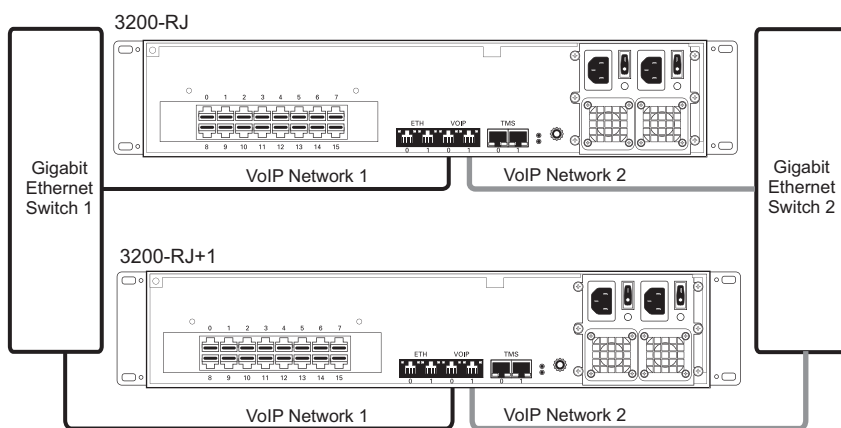

Figure 2.12 Connecting to the VoIP Network

2.5.4 Connecting to the PSTN in a 3200 Series 1+1 System

Note This section only applies to the TMG3200 and TSG3200 systems.



The 3200 Series 1+1 system features a variety of interfaces to the PSTN network.

Prerequisites

To connect to the PSTN network, you must comply with one of the following:

- Your 3200-RJ and 3200-RJ+1 feature 16 modular 8-conductor RJ48C type jacks for connection to T1/E1 lines. You will need one cable for each (T1/E1) interface. If you are making your own cables, refer to Section A.1 “RJ48C Wiring Diagram: Crossover and Straight Cables” on page 64 for crossover or straight cable wiring connections.
- Your 3200-TE and 3200-TE+1 feature SCSI connectors for connection to T1/E1 lines. You will require one 1+1 patch panel for each 32 line grouping of T1/E1 line interfaces on a 3200 series 1+1 system.
- Your 3200-DS3 and 3200-DS3+1 feature BNC connectors for connection to DS3 lines. You will require two coaxial cables for each DS3 interface.
- Your 3200-STM1 and 3200-STM1+1 feature electrical or optical STM-1 connectors. You will require two fibre optic cables for each STM-1 interface.

2.5.4.1

RJ48C Type Interface (T1/E1) for the 3200-RJ and 3200-RJ+1



A 3200 Series 1+1 system with an RJ TDM interface featuring 16 RJ48C type ports enables the connection to T1/E1 lines. The termination impedance is set at 100 ohms for T1 lines and 120 ohms for E1 lines. It is possible to connect an external balun in order to convert to 75 ohms. If you are making your own cables, refer to Section A.1 “RJ48C Wiring Diagram: Crossover and Straight Cables” on page 64 for crossover or straight cable wiring connections.

Note All ports may not be active. T1/E1 ports are activated by software license; the number of active ports depends on the licenses purchased.

Patch panels use straight connections. In other words, they do not cross the RX and TX signals. Connections between the patch panels and a 3200 series 1+1 system require straight cables. The supplied T1/E1 cables are straight cables. Cables used to connect the network to the 1+1 patch panel must do the cross connection.

To connect both the 3200-RJ and 3200-RJ+1 (RJ48C type) to the PSTN:

1. Connect T1/E1 lines 0-7 from the network section of the 1+1 patch panel to the remote equipment. See figure 2.13 on page 35.
2. Connect T1/E1 lines 0-7 from the RJ48C connectors of the Gateway section of the 1+1 patch panel to the 3200-RJ.
3. Connect T1/E1 lines 0-7 from the RJ48C connectors of the Gateway 1+1 section of the 1+1 patch panel to the 3200-RJ+1.

Note To connect eight more lines to the 3200-RJ and the 3200-RJ+1, install another 1+1 patch panel and connect the additional eight lines to ports 8-15 on each unit.

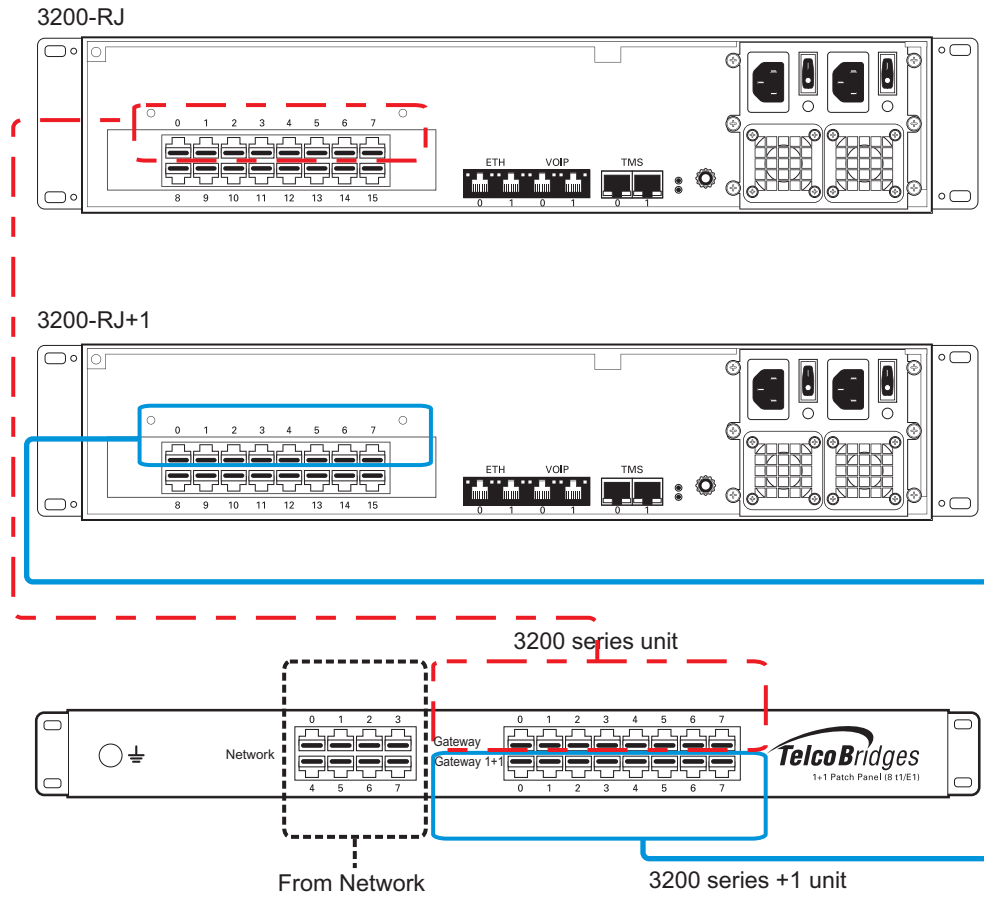

Figure 2.13 3200-RJ and 3200-RJ+1 connecting to the TDM 1+1 8/T1/E1 1+1 patch panel

2.5.4.2

SCSI Interface (T1/E1) for the 3200-TE and 3200-TE+1

A 3200-TE and 3200-TE+1 each with 4 SCSI connectors enables the connection to T1/E1 lines. The termination impedance is set at 120 ohms. It is possible to connect an external balun in order to convert to 75 ohms.



Note All ports may not be active. T1/E1 ports are activated by software license; the number of active ports depends on the licenses purchased.

Patch panels use straight connections. In other words, they do not cross the RX and TX signals. Connections between patch panels and 3200 series 1+1 systems requires straight cables. (The supplied SCSI cables are straight cables.) Cables that are used to connect the network to the 1+1 patch panel must make the cross connection.

To connect both the 3200-TE and 3200-TE+1 (SCSI) to the PSTN:

1. Connect each T1/E1 line from the network section of the 1+1 patch panel to the remote equipment. See figure 2.14 on page 37.
2. Connect SCSI ports 0-15 from the Gateway section at the rear of the 1+1 patch panel to the SCSI ports 0-15 of the 3200-TE.
3. Connect SCSI ports 16-31 from the Gateway section at the rear of the 1+1 patch panel to the SCSI ports 16-31 of the 3200-TE.
4. Connect SCSI ports 0-15 from the Gateway 1+1 section at the rear of the 1+1 patch panel to the SCSI ports 0-15 of the 3200-TE+1.
5. Connect SCSI ports 16-31 from the Gateway 1+1 section at the rear of the 1+1 patch panel to the SCSI ports 16-31 of the 3200-TE+1.

Note: To connect 32 more lines to the 3200-TE and the 3200-TE+1, install another 1+1 patch panel and connect the additional 32 lines to ports 32-63 on each unit.

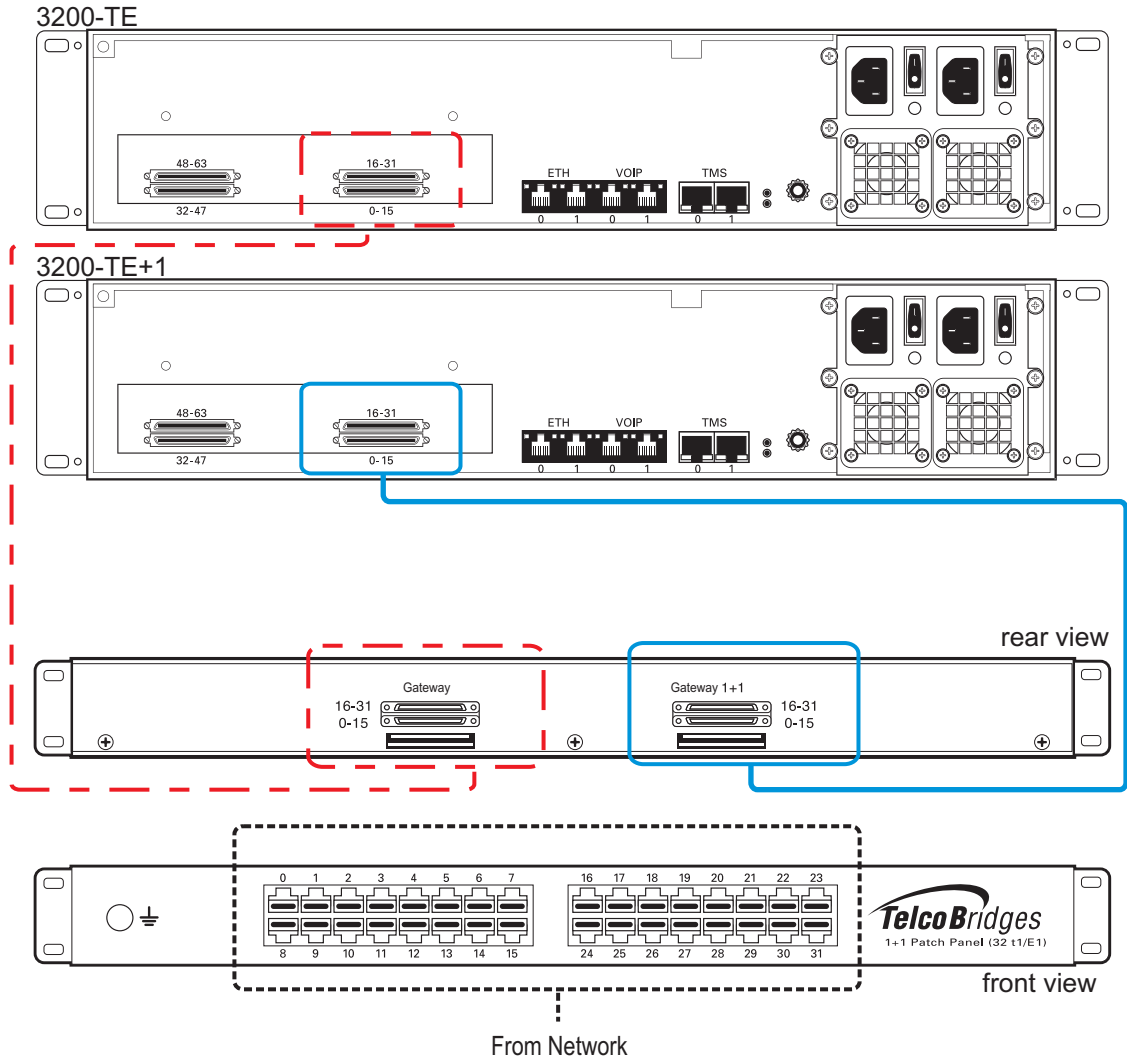

Figure 2.14 3200-TE and 3200-TE+1 connecting to the TDM 1+1 32/T1/E1 1+1 patch panel

2.5.4.3 Dual BNC Interface (DS3) for the 3200-DS3 and 3200-DS3+1

A 3200-DS3 and 3200-DS3+1 each with 3 sets of BNC connectors enables the connection to DS3 lines. See figure 2.15 on page 38.



Note All ports may not be active. DS3 ports are activated by software license; the number of active ports depends on the licenses purchased.

Patch panels use straight connections. In other words, they do not cross the RX and TX signals. You must connect RX to RX, and TX to TX between the 1+1 patch panels and 3200 Series 1+1 system. Cables used to connect the network to the 1+1 patch panel must do the cross connection.

To connect both the 3200-DS3 and 3200-DS3+1 to the PSTN:

1. Connect each DS3 line from the network section of the 1+1 patch panel to the remote equipment. See figure 2.15 on page 38.
2. Connect each DS3 line from the DS3 connectors of the Gateway section of the 1+1 patch panel to the 3200-DS3.
3. Connect each DS3 line from the DS3 connectors of the Gateway 1+1 section of the 1+1 patch panel to the 3200-DS3+1.

Optional

1. Connect bits port 0 and 1 from the 3200-DS3 to the 1+1 patch panel
2. Connect bits port 0 and 1 from the 3200-DS3+1 to the 1+1 patch panel

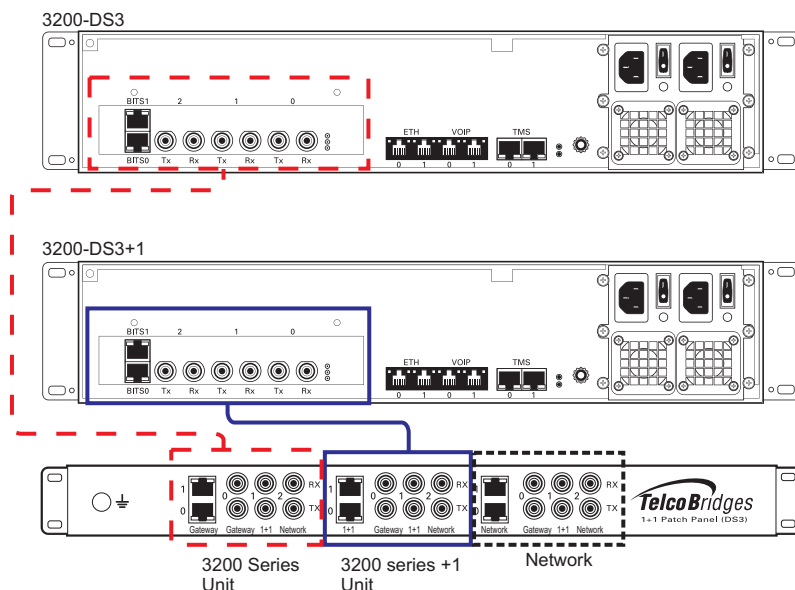

Figure 2.15 3200-DS3 and 3200-DS3+1 connecting to the TDM 1+1 DS3 1+1 patch panel

2.5.4.4 Optical Interface (OC3/STM-1)

A 3200-STM1 and 3200-STM+1, each with one main and one backup OC3 or STM1 port enables the connection to OC3/STM1 lines. See figure 2.16 on page 40. Refer to table 2.4 on page 39 for a listing of optical interfaces. The default SFP module for OC3/STM1 connection is SMF, intermediate reach, (SFP-OC3-IR1) 1310 nm with LC type connectors.



Note Make certain that the correct SFP model is selected at the time of ordering. If your installation requires a different model from the one that has been provided, you must replace it.

Table 2.4 Optical Interfaces

Transceiver Model	Description	Spec	Mode	Type	Range (Km.)	Wavelength (NM)	Connection
SFP-OC3-IR1	OC3/STM1	Hot Pluggable	Single-mode	Intermediate reach	15	1310	LC
SFP-STM1E	STM1E (Electrical)	Hot Pluggable	75 ohms Cooper	Max 180m	1	NA	DIN (mini-coax)

Automatic Protection Switching

The APS port is used for OC3/STM1 redundancy. Switchover occurs automatically based on configurable parameters. It is recommended that APS be used if the installation provides this feature.

Note Patch panels use straight connections. In other words, they do not cross the RX and TX signals. You must connect RX to RX, and TX to TX between the 1+1 patch panels and 3200 series 1+1 system. Cables used to connect the network to the 1+1 patch panel must do the cross connection.

To connect both the 3200-STM1 and 3200-STM +1 (Optical Interface) to the PSTN:

1. Connect each OC3/STM1 line of the network section of the 1+1 patch panel to the remote equipment. See figure 2.16 on page 40.
2. Connect a fiber optic cable between STM1 of the Gateway section of the 1+1 patch panel and the main port of the 3200-STM1.
3. Connect a fiber optic cable between APS of the Gateway section of the 1+1 patch panel and the APS port of the 3200-STM1.
4. Connect a fiber optic cable between STM1 of the Gateway 1+1 section of the 1+1 patch panel and the main port of the 3200-STM1 +1.
5. Connect a fiber optic cable between APS of the Gateway 1+1 section of the 1+1 patch panel and the APS port of the 3200-STM1 +1.

Optional

1. Connect bits port 0 and 1 from the 3200-STM1 to the 1+1 patch panel
2. Connect bits port 0 and 1 from the 3200-STM1+1 to the 1+1 patch panel

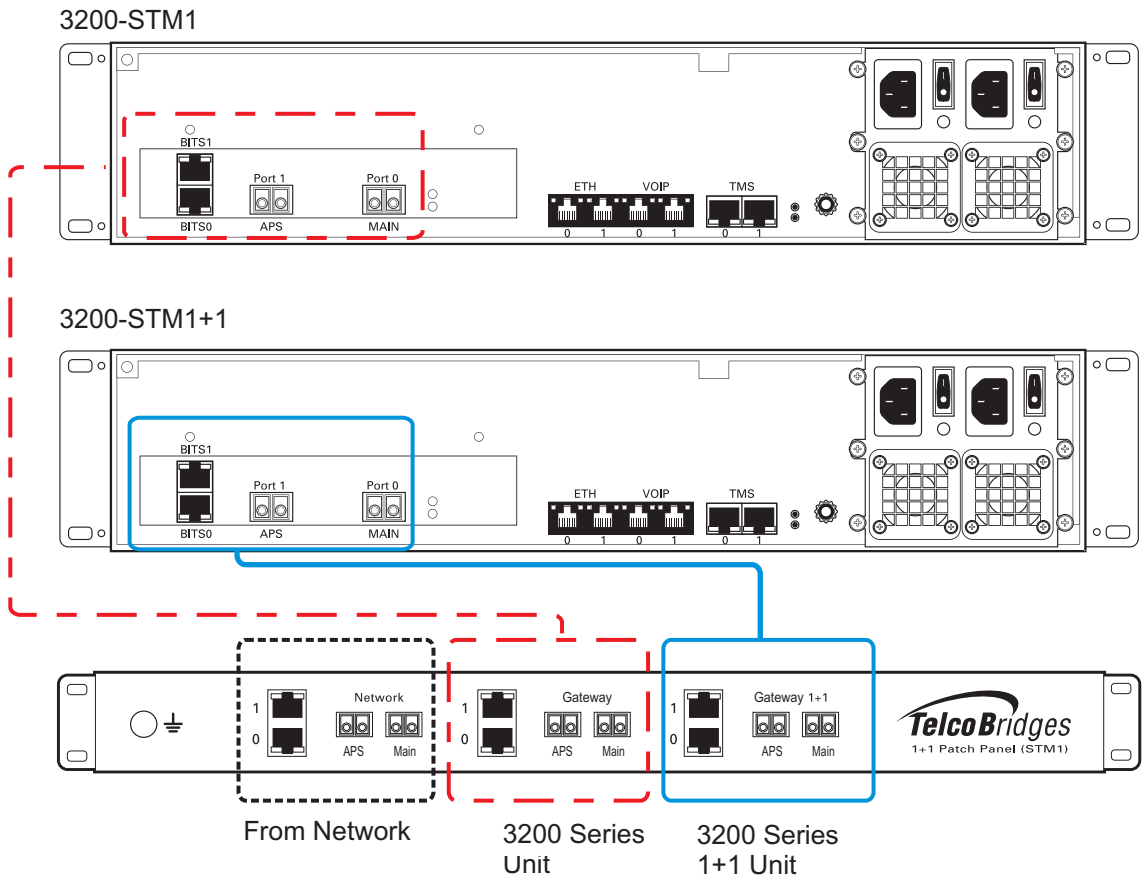

Figure 2.16 3200-STM1 and 3200-STM1 +1 connecting to the STM1 1+1 patch panel

2.5.5 Powering Up

The 3200 series unit and 3200 series +1 unit are furnished with two (2) AC or two (2) DC power connections. Only once all other equipment installation work has been completed should the 3200 series 1+1 system be powered up.



Prerequisites

To connect power you will need:

- Two independent AC power sources.
- Two power cables for each 3200 series unit and 3200 series +1 unit.

2.5.5.1 Connecting to AC Power

The 3200 series and 3200 series +1 AC models are furnished with two AC power connectors.

To connect to AC Power:

1. Connect the first power connector of each unit to the first power source. See Figure 2.17.
2. Connect the second power connector of each unit to the second power source.

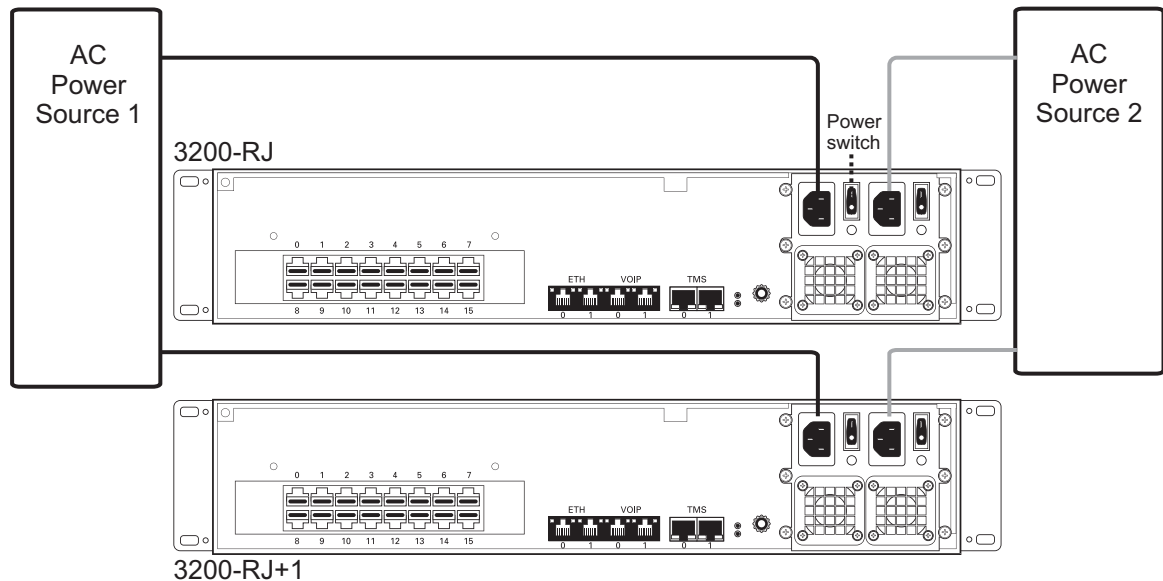

Figure 2.17 3200 Series and 3200 Series +1 AC Power Connections

2.5.5.2 Connecting to DC Power

The 3200 series and 3200 series +1 DC models are furnished with two DC power connection ports. In addition, each DC powered device is supplied with two DC power cables.



To connect the 3200 series and 3200 series +1 unit to DC Power

1. Connect the first DC power connector of the 3200 series and 3200 series +1 units to DC power source one. See figure 2.18 on page 42.
 - 1a. Connect one lead of each DC power cable to the positive terminal of the DC power source.
 - 1b. Connect the other lead of each DC power cable to the negative side of the DC power source.
2. Repeat the previous steps for DC power source two.

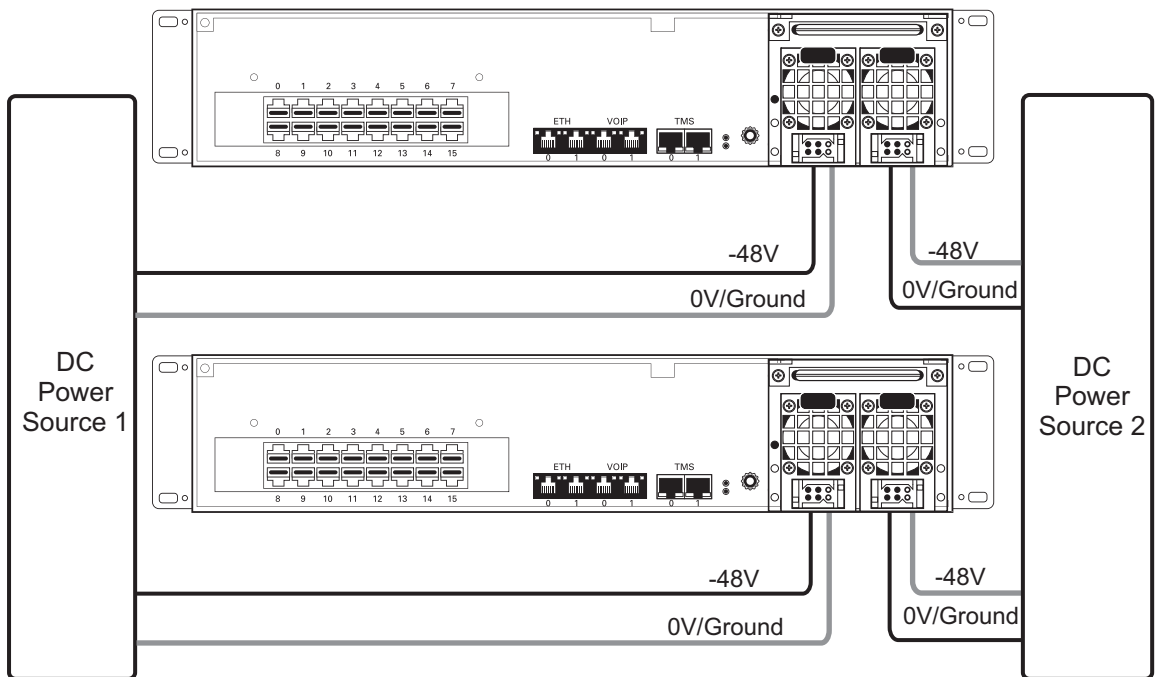

Cable Type	Voltage	
	0v/Ground	-48V
Yellow/Black	Black	Yellow
Red/Black	Red	Black

NOTE:
One of two types of DC power cable are supplied (Black/Red or Yellow/Black)

Figure 2.18 3200 Series and 3200 Series +1 DC Power Connections

2.5.6 Start Up

After powering up the 3200 series 1+1 system, you must configure both units, one as primary and the other as secondary.



Once these configuration settings have been applied, your 3200 series 1+1 system will start up and display the web portal configuration management tool.

1. Connect to the web portal. The Welcome page appears.

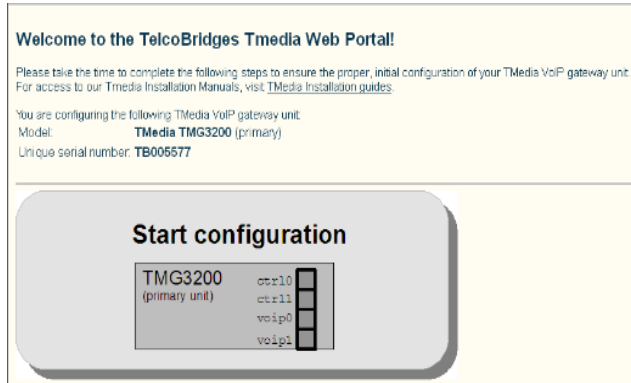

Note: The Welcome page indicates whether the 3200 series unit is primary or secondary.

2. Follow the instruction of the web portal to configure your unit as a new 3200 series 1+1 system.
3. Before clicking the **Yes, it's connected like that already**, verify that the physical connections have been properly done.

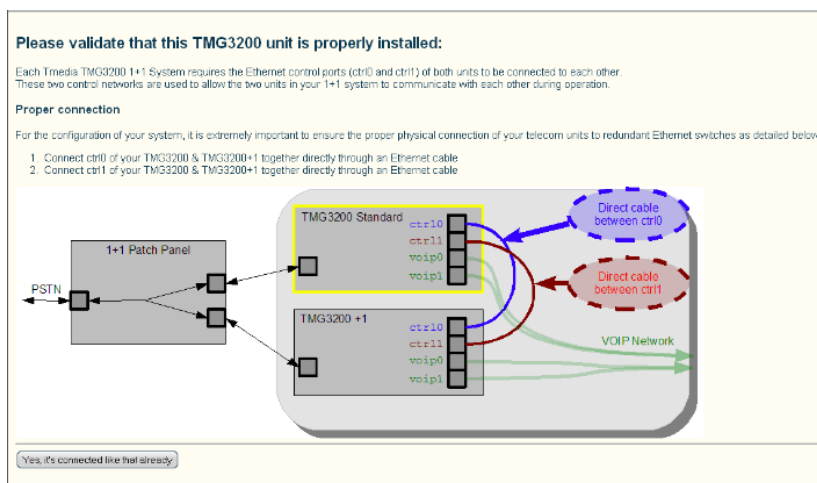

The Progress page is displayed.



Configuration is now in progress...



Configuration may take several minutes (up to ~3 minutes)
It may be impossible to refresh this web page at some point during that period.

If after the elapsed time you do not see any progress, please cancel the configuration to start again.

Cancel configuration

2.6 Adding a 3200 Series +1 Unit to an Existing Standalone, Creating a 3200 Series 1+1 System



Warning: This procedure will require some system downtime.

In order to add a 3200 series +1 unit to a 3200 series standalone unit, you must perform the following procedures:

- Section 2.6.1 “Reconfigure a Standalone Unit as a Primary Unit in a 3200 Series 1+1 system”
- Section 2.6.2 “Install the 3200 Series +1 Unit on the Equipment Rack”
- Section 2.6.3 “Install a 1+1 Patch Panel”
- Section 2.6.4 “Connect to the 3200 Series 1+1 Management Interface”
- Section 2.6.5 “Connect to the 3200 Series 1+1 Control Network”
- Section 2.6.6 “Connect to the VoIP Network”
- Section 2.6.7 “Connect to the PSTN Network”
- Section 2.6.8 “Power Up the 3200 Series 1+1 System”
- Section 2.6.9 “Start Up”

2.6.1 Reconfigure a Standalone Unit as a Primary Unit in a 3200 Series 1+1 system

1. Connect to the web portal of the standalone 3200 series unit.
2. Select **Status** from the navigation panel.
3. Select the **Hosts** status tab.

name	value
Ready cnt	1
Not ready cnt	0
Disk full cnt	0
Fack recommended cnt	0
Fack required cnt	0
Ready host list	TB005377
Not ready host list	
Disk full host list	
Fack required host list	
Fack recommended host list	

4. Select **ResetHostRole** for the action, and click **Apply Action**.



Host Status - TB005577

Status Options
 Refresh every:

Extended status

Host | Processor Usage | Memory Usage | Filesystem Usage | Network Interfaces

Name	Value
Host	TB005577
Host role	Standalone
Can reboot	Master
Can start	Ready
Engaged	Yes
Host platform	TMG3200 CentOS
Host platform	SR6_644xv84_centos6
Last lock	Tue Oct 18 18:07:53 2011
Fack status	No filesystem check required yet

Host Control
 Action:

Current Action Log

Last Action Log

```

VlanManagementReq: Starting
VlanManagementReq: Script completed successfully
VlanManagementReq: Done
    
```

5. Reconnect to the same 3200 series unit. The Welcome page appears.

Welcome to the TelcoBridges Tmedia Web Portal!

Please take the time to complete the following steps to ensure the proper, initial configuration of your TMedia VoIP gateway unit. For access to our Tmedia Installation Manuals, visit [Tmedia Installation guides](#).

You are configuring the following TMedia VoIP gateway unit:
 Model: **TMedia TMG3200** (primary)
 Unique serial number: **TB005577**

Start configuration

TMG3200	ctrl0	<input type="checkbox"/>
(primary unit)	ctrl1	<input type="checkbox"/>
	voip0	<input type="checkbox"/>
	voip1	<input type="checkbox"/>

6. Follow the web portal instructions to configure your unit as a primary unit in a new 3200 series 1+1 system.

2.6.2 Install the 3200 Series +1 Unit on the Equipment Rack

The 3200 series +1 unit is mounted on a customer provided equipment rack using the mounting hardware packaged in the box. Refer to Section 2.2 “Rack Mounting the 3200 Series Standalone or 3200 Series 1+1 System” on page 12.



2.6.3 Install a 1+1 Patch Panel

Note This section only applies to the TMG3200 and TSG3200.

<p>If your system features a 3200-RJ TDM interface, use a 1+1 patch panel (8/T1/E1). Refer to Section 2.5.4.1 “RJ48C Type Interface (T1/E1) for the 3200-RJ and 3200-RJ+1” on page 34.</p>	
<p>If your system features a 3200-TE TDM interface, use a 1+1 patch panel (32/T1/E1). Refer to Section 2.5.4.2 “SCSI Interface (T1/E1) for the 3200-TE and 3200-TE+1” on page 36.</p> <p>Note: Patch panels must be replaced by the 3200-TE-1+1 patch panels.</p>	
<p>If your system features a 3200-DS3 TDM interface, use a 1+1 patch panel (DS3). Refer to Section 2.5.4.3 “Dual BNC Interface (DS3) for the 3200-DS3 and 3200-DS3+1” on page 38.</p>	
<p>If your system features a 3200-STM1 TDM interface, use a 1+1 patch panel (STM1). Refer to Section 2.5.4.4 “Optical Interface (OC3/STM-1)” on page 39.</p>	

2.6.4 Connect to the 3200 Series 1+1 Management Interface

The Management interface enables administrators to perform management tasks on a 3200 series 1+1 system.

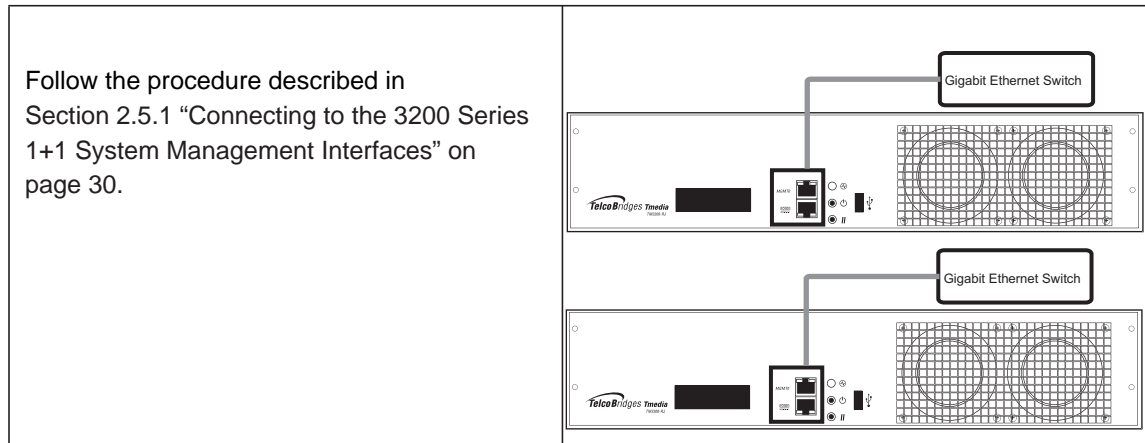

2.6.5 Connect to the 3200 Series 1+1 Control Network

The control network permits a 3200 series unit to connect to a 3200 series +1 unit, thereby enabling a sharing of system resources.

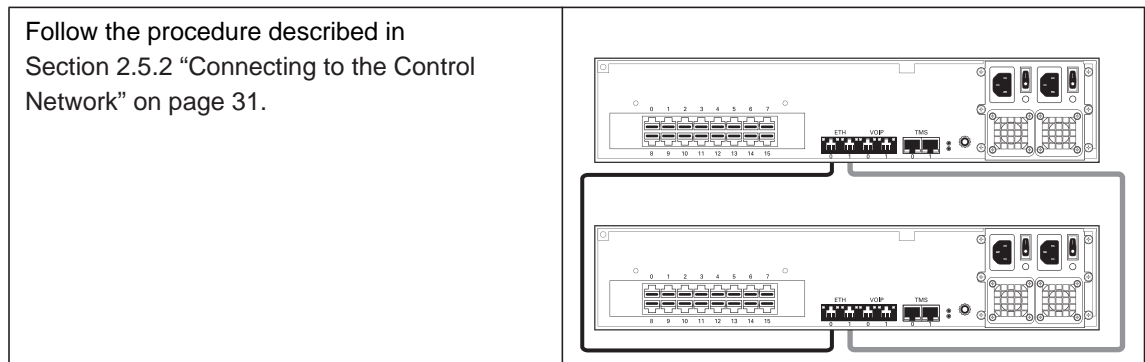

2.6.6 Connect to the VoIP Network

The 3200 series 1+1 system features dual GigE ports for connection to different VoIP networks. This provides an access point to manage VoIP traffic. Should one of the IP networks fail, the 3200 series 1+1 system will continue to manage VoIP traffic using the alternate network.

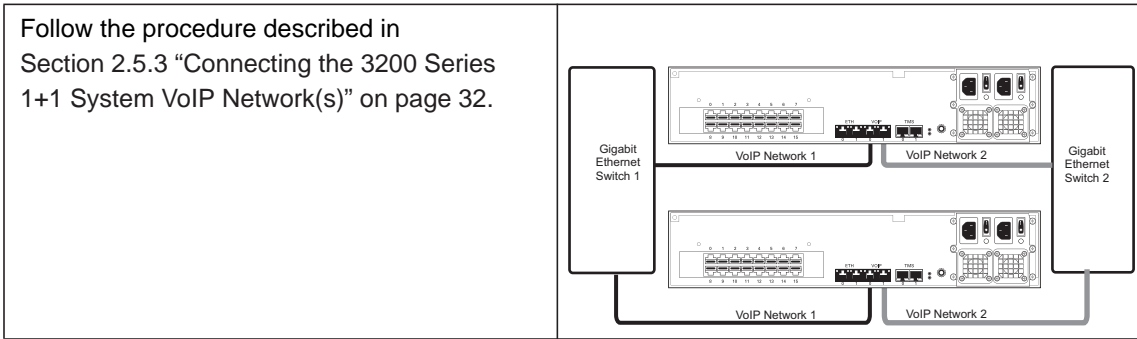

2.6.7 Connect to the PSTN Network

Note This section only applies to the TMG3200 and TSG 3200.

3200 series gateways feature a variety of interfaces to the PSTN network.

<p>If your system features a 3200-RJ TDM interface, refer to Section 2.5.4.1 “RJ48C Type Interface (T1/E1) for the 3200-RJ and 3200-RJ+1” on page 34.</p>	
<p>If your system features a 3200-TE TDM interface, refer to Section 2.5.4.2 “SCSI Interface (T1/E1) for the 3200-TE and 3200-TE+1” on page 36.</p> <p>Patch panels must be replaced by the 1+1 patch panel.</p>	
<p>If your system features a 3200-DS3 TDM interface, refer to Section 2.5.4.3 “Dual BNC Interface (DS3) for the 3200-DS3 and 3200-DS3+1” on page 38.</p>	
<p>If your system features a 3200-STM1 TDM interface, refer to Section 2.5.4.4 “Optical Interface (OC3/STM-1)” on page 39.</p>	

2.6.8 Power Up the 3200 Series 1+1 System



The 3200 series and 3200 series +1 units are furnished with either two AC or DC power connections. Only once all other equipment installation work has been completed should the 3200 series 1+1 system be powered up.

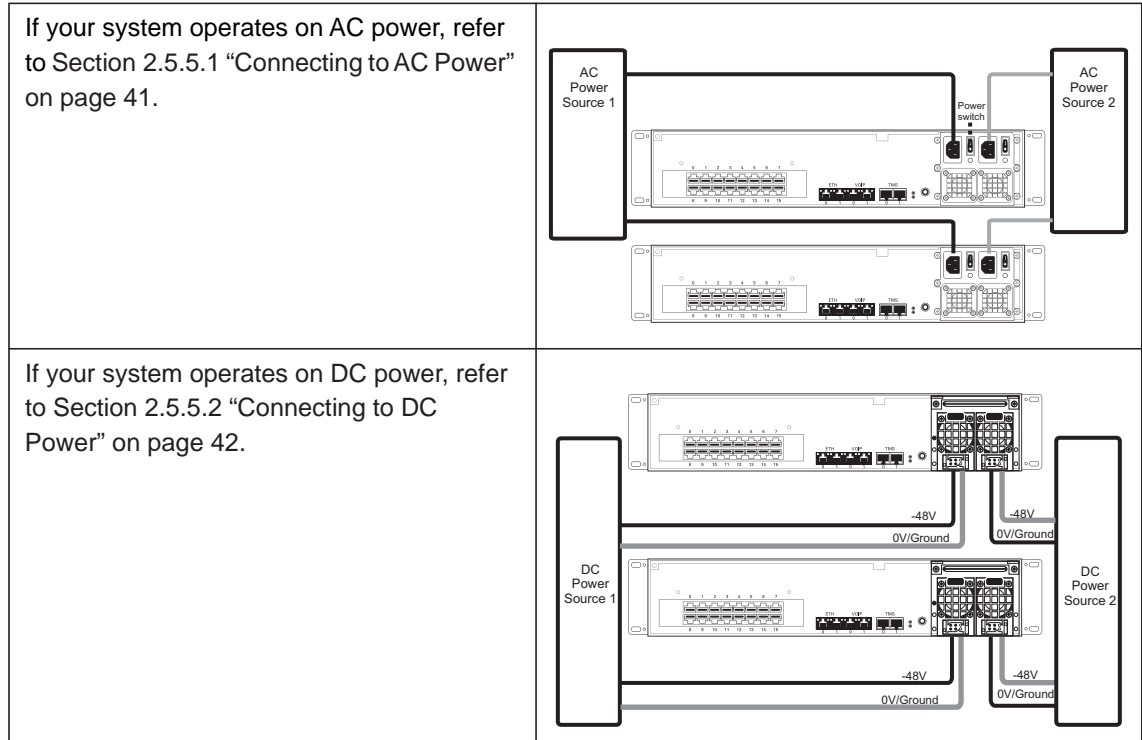

2.6.9 Start Up

1. Connect to the web portal of the 3200 series 1+1 system. The Welcome page appears.

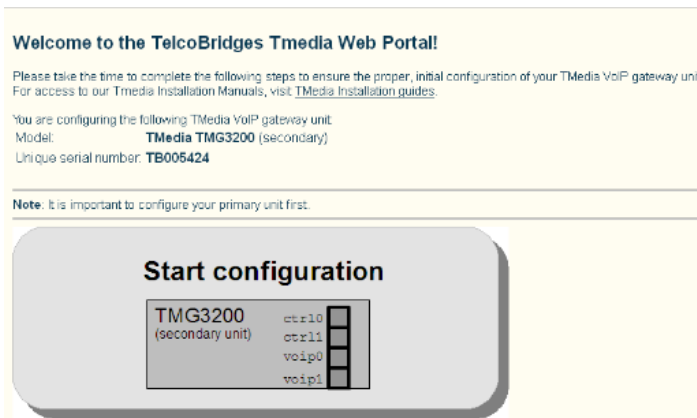

2. Follow the web portal instructions to configure your unit as a secondary unit in a new 3200 series 1+1 system.
3. Before clicking the “**yes, it is connected like that already**” button, make sure that the physical connections have been properly done.



2.7

Verifying the LED Status Indications

When the 3200 series 1+1 system has been powered up, verify the front panel of the unit to determine that all indications are normal.

Once the 3200 series 1+1 system has run successfully through its system boot procedures, the following will be displayed in an alternating fashion as described in table 2.5 on page 52:

Table 2.5 3200 Series System Displays

Display Order	Display
First Screen	IP 0: <ip address of eth0. E.g. 192.168.0.2> IP 1: <ip address of eth1 E.g. 192.168.0.3>
Second Screen	<board type.. eg. TMP-STM1, TMS-16, TMP-DS3, TMP-16, TMP-32, TMP-64> <adapter name e.g. TB002821> <serial number e.g. TB002821> <release used e.g V2.2.0 RC1>

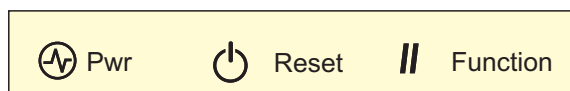
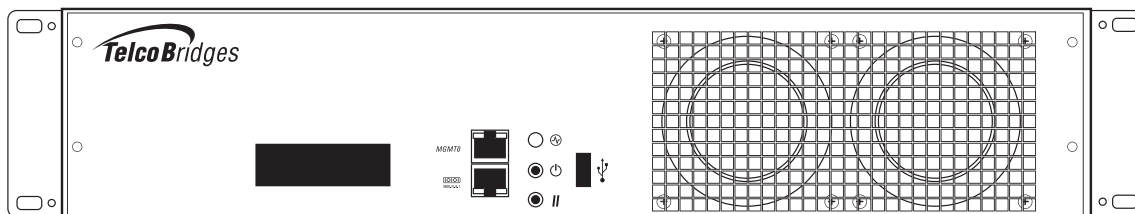

Figure 2.19 Front display and LEDs

If the reset button is pressed a software menu will appear on the display at the front of the unit. Press the function button to select one of the three actions listed in table 2.6 on page 53. Once your selection is made, press the reset button to acknowledge your choice.

Table 2.6 Reset Menu Options

Menu Choices	Description
M Options:	
e >Shutdown	Graceful shutdown of the 3200 series 1+1 system. This takes a few minutes. Press the reset button to restart the system.
n Rst telecom	Reboots the telecom platform of the 3200 series 1+1 system.
u Rst host	Reboots the linux host of the 3200 series 1+1 system.





2.8

Powering Down

Powering down the 3200 series 1+1 system requires that the Linux embedded host be shut down. In order to do this, you must connect to the management interface using SSH, and enter:

```
shutdown -hP now
```

Attention DO NOT TURN OFF the power to the 3200 series gateway using the power switch located at the rear, unless the Linux host has been properly shut down beforehand, instead use the reset button display, or manually use the shutdown command.

Allow enough time for the Linux host to shut down before turning off the power to the 3200 series system (example. 1 minute). Be aware that the shutdown procedure of the unit is logged and traceable for support and warranty purposes.

Note As an alternate method to this procedure, refer to Section 2.7 “Verifying the LED Status Indications” on page 52, to power down the 3200 series 1+1 system with the reset button.



Section 3 Initial System Configuration

This chapter provides information about the following topics:

- Section 3.1 “Connecting to the Serial Port of the 3200 Series Gateway”
- Section 3.2 “Configuring the Terminal Emulator Application”
- Section 3.3 “Connecting to the 3200 Series Gateway”
- Section 3.4 “Retrieving 3200 Series Gateway Information”
- Section 3.5 “Changing the 3200 Series Gateway Management Port IP Address”
- Section 3.5 “Changing the 3200 Series Gateway Management Port IP Address”
- Section 3.7 “Setting the Time Zone”
- Section 3.8 “Configuring the 3200 Series Gateway Using the Web Portal”
- Section 3.9 “Changing VoIP Interface Addresses”



3.1

Connecting to the Serial Port of the 3200 Series Gateway

Note By default, the management port is set to DHCP.

Sections 3.1 and 3.2 provide instructions on how to convert the DHCP management port to a static IP address. If your network supports DHCP, skip sections 3.1 and 3.2.

The serial port interface enables administrators to perform management tasks on the 3200 series gateway.

To connect to the serial port of a 3200 series gateway:

1. Connect a CAT5 RJ-45 (male-male) cable (supplied with unit) between the com port of your computer and the serial port (labelled 10101) of the 3200 series gateway as shown in figure 3.1 on page 56. See Section A.2 on page 64 for a RJ-45 console wiring diagram.
2. If your computer's serial port features a DB9 connector, use the Tmedia serial adapter supplied with your 3200 series gateway. If your computer's serial port features a USB connector, you will need to provide a USB to DB9 adapter. Refer to figure 3.2 on page 56.

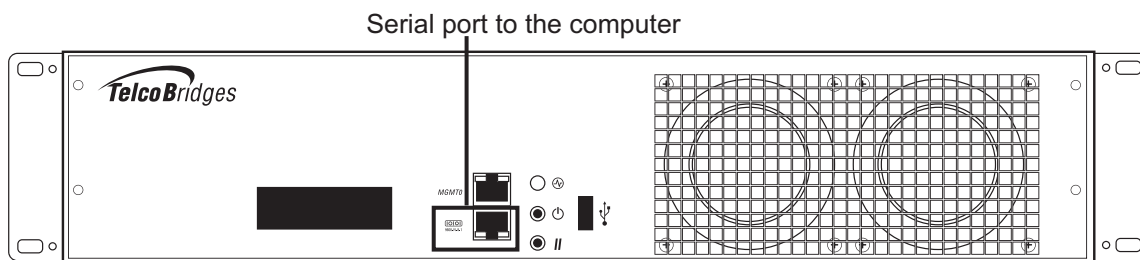

Figure 3.1

Computer to 3200 Series Gateway Serial Port Connection

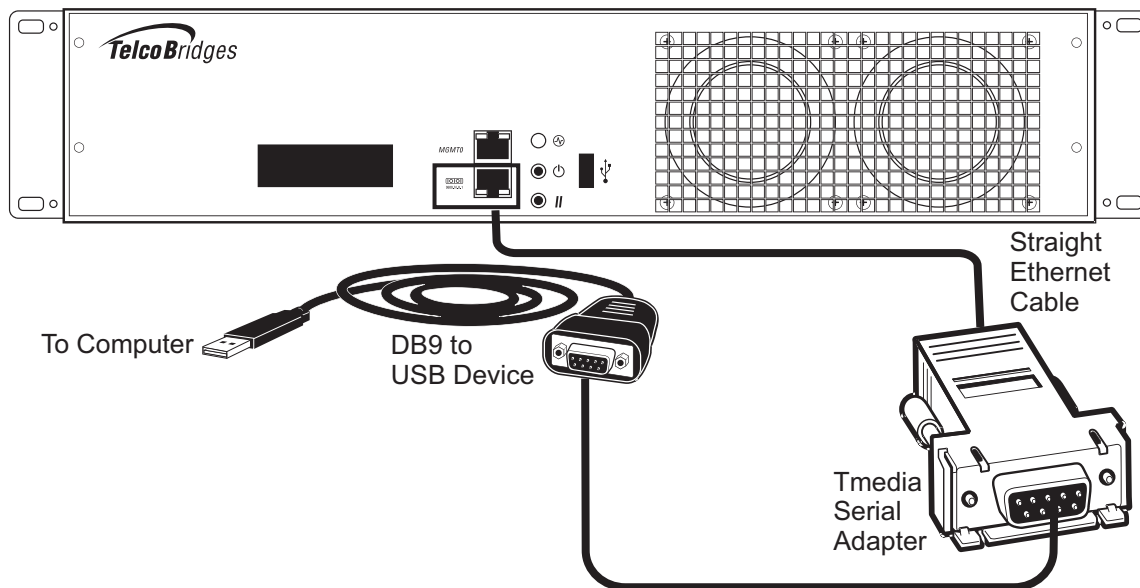

Figure 3.2

Conceptual View of a Serial Connection from the 3200 Series Gateway to a Computer

3.2 Configuring the Terminal Emulator Application

Before communicating with the management interface, you must first configure a terminal emulator or console application to communicate with the 3200 series system in order to configure initial settings. Available terminal emulation software includes:

- HyperTerminal
- Putty
- Minicom

To configure the terminal emulator application:

1. Set the baud rate (bits per second) to **9600**
2. Set the data rate to **8 bits**
3. Set the parity to **None**
4. Set the stop bits to **1**
5. Set the flow control to **None**

Note See Section 3.5 on page 58 to learn how to change the IP address of the MGMT0 port.

3.3 Connecting to the 3200 Series Gateway

The 3200 Series Gateway is shipped with the TMG-CTRL preinstalled. In order to make changes to the system configuration, you must connect the port labelled MGMT0 at the front of the 3200 Series Gateway to a terminal.

To access the 3200 Series Gateway, you must use an SSH connection. The password is set at the factory and is indicated on the shipment sheet.

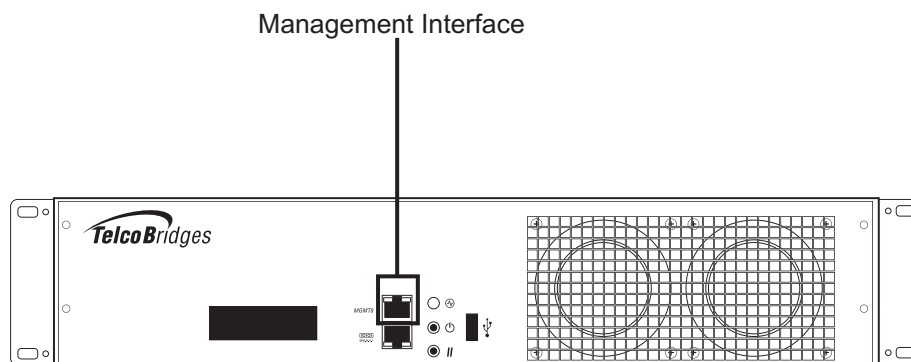

Figure 3.3 3200 Series Gateway Management Interface





3.4

Retrieving 3200 Series Gateway Information

The 3200 series gateway enables you to retrieve system information with the following shell commands:

- `tbproduct` (retrieve the 3200 series gateway product type). See http://docs.telcobridges.com/mediawiki/index.php/TMG:Get_Product_Type, for further information.
- `tbserial` (retrieve the 3200 series gateway serial number). See http://docs.telcobridges.com/mediawiki/index.php/TMG:Get_Serial_Number, for further information.



3.5

Changing the 3200 Series Gateway Management Port IP Address

Note The following procedure must be performed on the 3200 series standalone unit or the 3200 series 1+1 system.

The management port of the 3200 series gateway (labeled MGMT0) is configured using DHCP by default. It can be modified it using the following shell script:

- `tbchangeip`. See http://docs.telcobridges.com/mediawiki/index.php/TMG:Change_Management_IP_Address, for further information.

3.6

Changing 3200 Series Gateway Management Port Passwords

Note The following procedure must be performed on 3200 series standalone or the 3200 series 1+1 system.

Once logged you are logged on to the 3200 series gateway, type “passwd”, to change the password being used. The following information will be displayed:

```
[root@TB003540 ~]# passwd
Changing password for user root.
New UNIX password:
Retype new UNIX password:
passwd: all authentication tokens updated successfully.
```

3.7

Setting the Time Zone

Note The following procedure must be performed on 3200 series standalone unit or the 3200 series 1+1 system.

You can change the time zone of the 3200 series gateway using the `tbtimezone` shell command.

3.8 Configuring the 3200 Series Gateway Using the Web Portal



Note: The first time that you connect to the web portal, you will need to configure the role of the 3200 series unit.

If your system features a 3200 series standalone unit, refer to Section 2.4.5 “Start Up” on page 27.

If your system features a 3200 series unit working in conjunction with a 3200 series +1 unit, refer to Section 2.5.6 “Start Up” on page 43.

To change the default configuration of a 3200 series gateway using the Web Portal, follow the steps described in the Web Portal System Configuration Tutorial Guide, found on the TBWiki:

<http://docs.telcobridges.com>

The Web Portal can be accessed with a Web browser. The default url is: `http://[Gateway MGMT0 IP address]:12358`

Note 3200 series and 3200 series +1 unit s can access the Web Portal from either one of their IP addresses.

The default login information to access the Web Portal application is:

- Username: root
- Password: root

3.9 Changing VoIP Interface Addresses

The default address of the VoIP interfaces of the 3200 series gateway can be modified. To learn how this is done, refer to the Web Portal tutorial guide on the Telcobridges TB Wiki at docs.telcobridges.com.

Note With regard to sections 3.2, 3.3, 3.4 3.5, 3.6 or 3.7, please visit the TBWiki at: <http://docs.telcobridges.com>



Section 4 System Backups

This chapter provides information about the following topics:

- Section 4.1 “Creating a Database Backup”
- Section 4.2 “Downloading a Database Backup”
- Section 4.3 “Uploading a Database Backup”
- Section 4.4 “Restoring a Database Backup”



For more detailed information with regard to any of the points described in this section, please refer to the TBWiki: <http://docs.telcobridges.com>



4.1 Creating a Database Backup

It is important that backups be made of system configuration settings in the event of a system failure. It is recommended that a backup be made once the system has been configured. Backups are performed using the web portal.

4.2 Downloading a Database Backup

A backup of system data is stored on the hard drive of the 3200 series gateway. It is important that system backups be downloaded to an external storage device.

4.3 Uploading a Database Backup

An external backup of your database can be uploaded to your 3200 series gateway.

4.4 Restoring a Database Backup

In the event of a system failure requiring the replacement of a 3200 series gateway, a previously saved backup of system settings can be restored to the new unit.



Appendix A Wiring Diagrams



A.1

RJ48C Wiring Diagram: Crossover and Straight Cables



RJ48C (T1/E1) Wiring Schematic: Crossover Cable

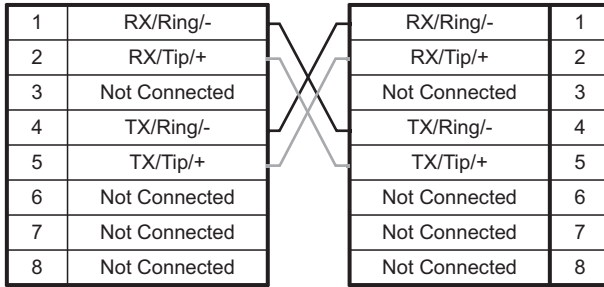

RJ48C (T1/E1) Wiring Schematic: Straight Cable

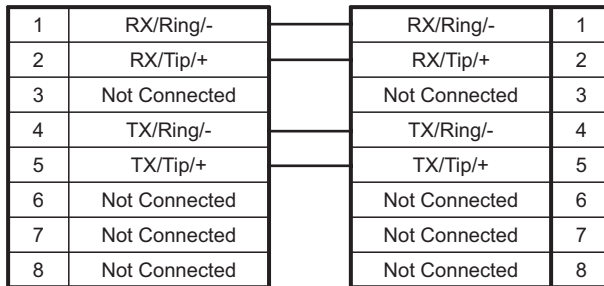

A.2

RJ48 Console Wiring Diagram

